

TechCalc User Guide

Thermal Calculation Software

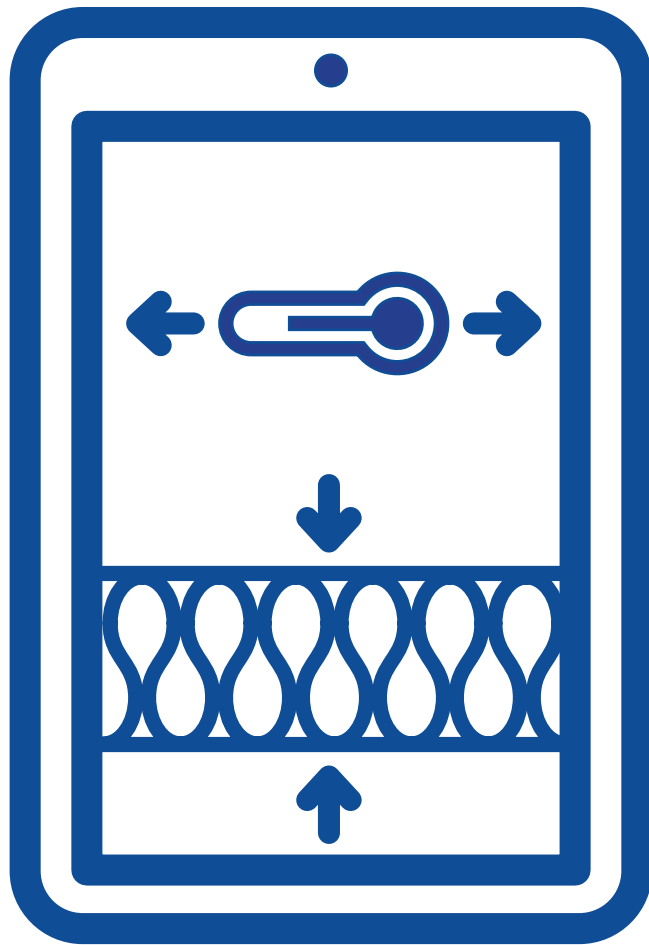

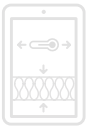



INDEX



A. INSTALLATION GUIDELINES

B. HOME SCREEN

1. Application selection
2. Open an existing file
3. Language selection

C. DATA INPUT STEPS

1. Components
 - i. Heat loss/gain and surface temperature
 - ii. Minimum insulation thickness
 - iii. Operational cost
 - iv. Axial temperature decrease of the flowing medium
 - v. Temperature decrease over the time
 - vi. Moisture accumulation on a cooling component
 - vii. Calculation U-R value
 - viii. Underground component
 - ix. Time it takes for the water inside component to freeze (0°C)
 - x. Economic cost
3. Medium
4. Climate
5. Insulation System
6. Thermal Bridges (Optional)
7. Economy (Optional)

D. OUTPUT

1. On Screen
2. Print out

E. OTHER FUNCTIONS

1. New project
2. Save file
3. Database access and manage
4. Personalize your report
5. Change language or database
6. Change units

F. CALCULATION EXAMPLES

G. DISCLAIMER

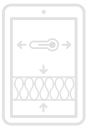

A. INSTALLATION GUIDELINES

Minimum requirements of your computer:

- » **Win 7, Win 8 or Win 10**
- » **Resolution: 1280x800**

Before proceeding to install TechCalc in your computer you need to have previously downloaded the installation file ( techcalc-2.0.1.1-12-setup). In case you don't have this installation file yet, please visit our website (<https://www.isover-technical-insulation.com>) and follow the information related to TechCalc 2.0 or contact to our local Sales Representative from the ISOVER local team in your Country.

Installation procedure is quite simple:

- i. **Accept the licence agreement**
- ii. **Choose the installation option**
- iii. **Introduce your destination folder**
- iv. **Wait until the installation is finished and choose if you want to use TechCalc immediately**

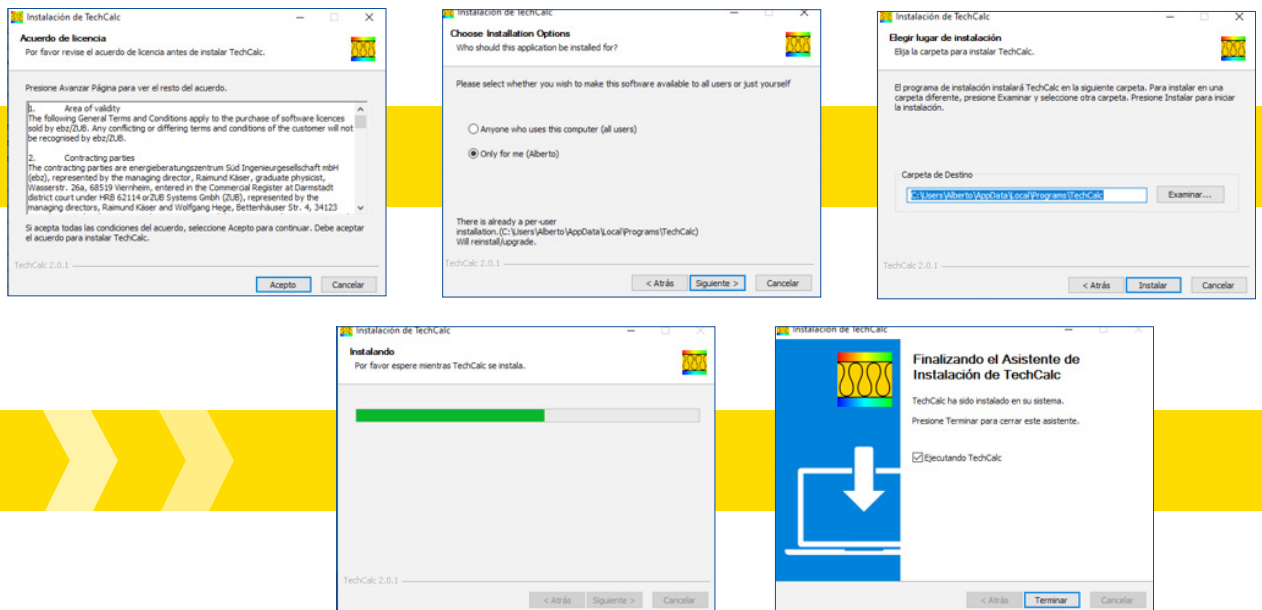

Once the installation is finished and when you use TechCalc for the first time, it will take some minutes to update the internal database.

Please, wait until it is finished without closing TechCalc:

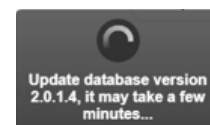

NOW YOU ARE READY TO START WITH TECHCALC EXPERIENCE!



B. HOME SCREEN

EVERY TIME YOU START TECHCALC YOU WILL ARRIVE TO THIS 'HOME' SCREEN:



- 1** Application Selection: HVAC - Industry - Marine
- 2** Open an existing TechCalc file (.json)
- 3** Select your language
- 4** Other functions (see chapter 'e' for further details)
- 5** Software and database versions installed

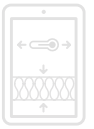

B1. APPLICATION SELECTION

You need to choose the kind of application of your project. You have 3 choices:

HVAC



INDUSTRY



MARINE



HVAC: Applications relative to the heating and cooling systems. Focus in ducts, pipes and walls thermal calculations.

INDUSTRY: Applications relative to any kind of insulation in industrial sites (pipes, boilers, tanks, vessels, ovens, etc.). Covers all calculation methods included in ISO 12241. You can also select VDI 2055 or ASTM C 680 calculation methods.

MARINE: Applications relative to any kind of insulation in ship (pipes, walls, tanks, vessels, etc.).

After selecting your application, you will start with the calculation steps (see chapter 'c')



B2. OPEN AN EXISTING FILE

TechCalc allow the user to save calculation files. These files have the special TechCalc extension '.json'. You can always recover this calculation files.

By clicking in this option:



You will get the next navigation screen where you will select the TechCalc file (.json) you want to restart:

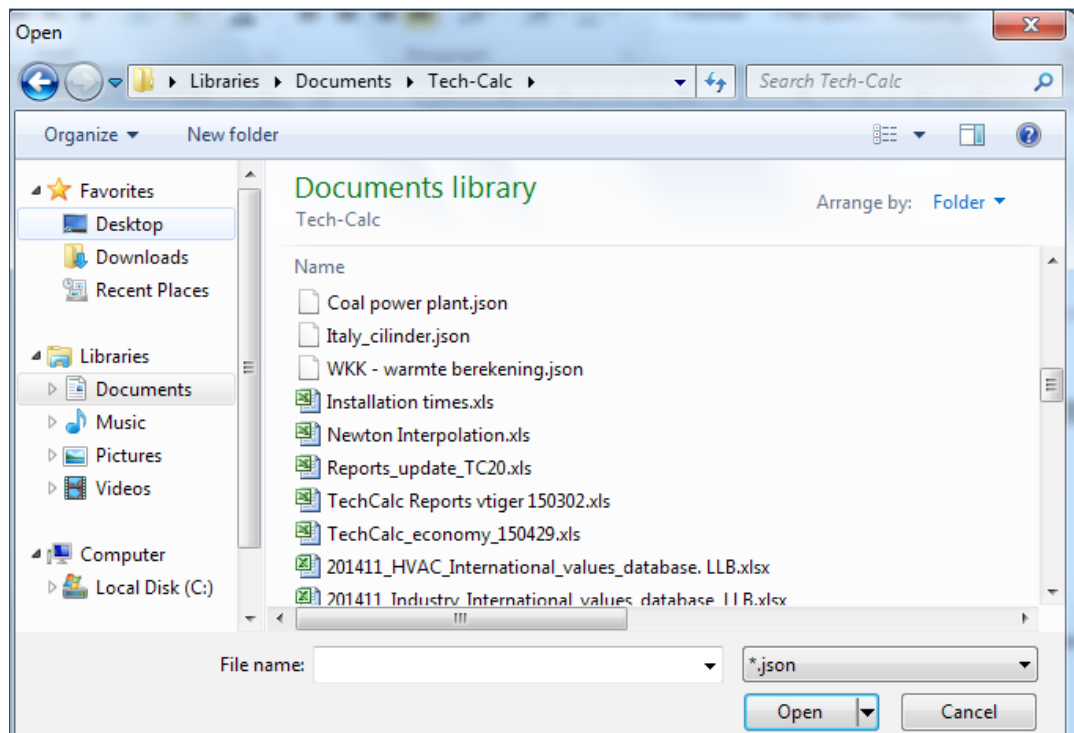

Once you select your file, click on 'Open' and you will have recovered all your calculation data and will be placed in calculation step 1 to modify or review any data of your previous calculation.

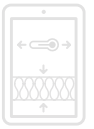

B3. LANGUAGE SELECTION

When you select a language you select two things: the language for the software and the local portfolio that ISOVER offers in your selected flag.

TechCalc is multilingual software. In next table you can see what your choices are depending in your selection:



TechCalc Language: English
Database: International portfolio



TechCalc Language: English
Database: UK portfolio



TechCalc Language: French
Database: French portfolio



TechCalc Language: German
Database: German portfolio



TechCalc Language: Spanish
Database: Spanish portfolio



TechCalc Language: Italian
Database: Italian portfolio



TechCalc Language: Dutch
Database: BENELUX portfolio



TechCalc Language: Finnish
Database: Finnish portfolio



TechCalc Language: English
Database: South African portfolio



TechCalc Language: English
Database: GCC portfolio

Once you have selected your language you will be back to 'Home Screen' for opening an existing file or selecting an application before starting up your calculations.

You can change your software language or your database whenever you want later on (see chapter 'e5 - change language or database')



FLAG SELECTION EXAMPLES:



CHOICE

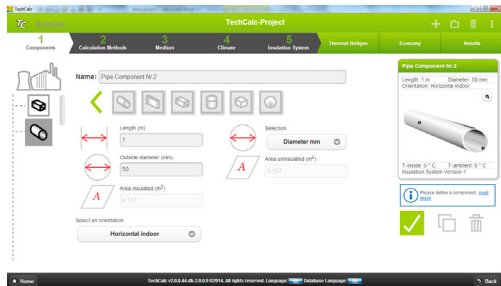

SOFTWARE LANGUAGE: ENGLISH



**DATABASE:
INTERNATIONAL PORTFOLIO**



CHOICE

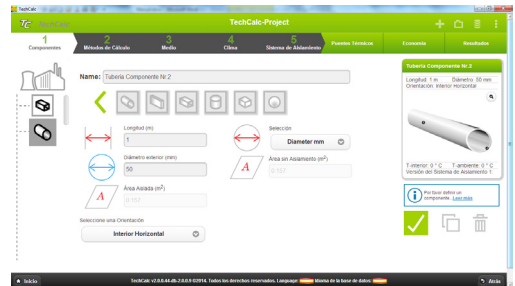

SOFTWARE LANGUAGE: SPANISH



**DATABASE:
SPANISH PORTFOLIO**

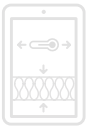

C. DATA INPUT STEPS

Data introduction to obtain the final calculated results is split in 5 main steps and 2 optional ones:

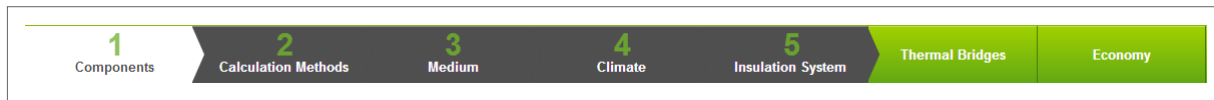

- » Calculation Methods
- » Medium
- » Climate
- » Insulation System
- » Thermal Bridges (Optional)
- » Economy (Optional)

The amount of input data required varies depending on different factors, like component position, chosen calculation method, medium type, etc. A detailed description of each step is given in the next chapters.

There are different areas in your screen that are common, no matter what your calculation step is:

TechCalc-Project

1 Components 2 Calculation Methods 3 Medium 4 Climate 5 Insulation System Thermal Bridges Economy Results

Name: Wall Component Nr.1_VDI

Length (m): 1

Height (m): 1

Area uninsulated (m²): 1

Area insulated (m²): 1

Standard: ISO VDI ASTM

Heatloss: $\uparrow q$ $\downarrow q$

Characteristic length (m): 0.25

Select an orientation: Horizontal indoor

Wall Component Nr.1_VDI

Heat loss/gain and surface temperature
Length: 1.00 m
Height: 1.00 m
Orientation: Horizontal indoor

T-inside: 250.00 °C T-ambient: 20.00 °C
Insulation System Version 1:
TECH Wired Mat MT 5.1

Please define a component. [read more](#)

Home TechCalc: v2.0.1.1-db2.0.1.4 © ZUB Systems GmbH. Locale: Database: Unit system: SI Back



- 1 **Component list:** you can create as many components as you want. There is no limit. The selected component appears with a dark shadow on it. To change the selection, just click on the component you want.
- 2 **Component window:** a summary with all dimensions and conditions linked to the selected component. You can make a zoom by just clicking in 
- 3 **Warning window:** any kind of warning will appear in this area. (i.e.- Maximum Service Temperature limit exceed, no possible calculation, etc.)
- 4 **Actions:** Go through, Copy and Delete

Go through: once that all your data is correct, in each step, confirm and go to the next step by clicking in the icon:



Copy: If you have to calculate different scenarios with the same component, this possibility offers you the opportunity of saving a lot of time. The only thing you need to replicate a certain component is click in this icon:



A new component will be created, inheriting all properties of the copied one and will appear in the component list.

Delete: To erase a component, just click on this icon and you will delete the selected component:



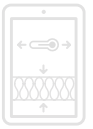

C1. COMPONENTS

You can create up to 6 different components:



**PIPES OR
CIRCULAR**



WALLS



**RECTANGULAR
DUCTS**



**CYLINDRICAL
TANKS**



**CUBICAL
TANKS**



**CYLINDRICAL
TANKS**

For creating a new component, just click on the component you wish and it will appear in the component list, on the left of you screen. Remember there is no limit for the amount of components you want to create.

At this step we will provide the main characteristics of the selected component (dimensions and position), the calculation method we want to use (ISO 12241, VDI 2055-2008, ASTM C 680) and the direction of heat flow in case of horizontal flat surfaces (VDI and ASTM calculation methods).

Shadowed area in next picture is the area to fill in the information linked with every component:

TechCalc TechCalc-Project

1 Components 2 Calculation Methods 3 Medium 4 Climate 5 Insulation System Thermal Bridges Economy Results

Name: Wall Component Nr.1_VDI

Length (m): 1

Height (m): 1

Area un-insulated (m²): 1

Area insulated (m²): 1

Standard: ISO VDI ASTM

Heatloss: $\uparrow q$ $\downarrow q$

Characteristic length (m): 0.25

Select an orientation: Horizontal indoor

Wall Component Nr.1_VDI

Heat loss/gain and surface temperature

Length: 1.00 m

Height: 1.00 m

Orientation: Horizontal indoor

T-inside: 25.00 °C T-ambient: 20.00 °C

Insulation System Version 1: TECH Wired Mat MT 5.1

Please define a component... [read more](#)

TechCalc v2.0.1.1-db2.0.1.4 © ZUB Systems GmbH. Locale: Database: Unit system: SI

Inputs requirement changes depending on the component selection.





PIPES:

 Length (m)

 Outside diameter (mm)

 Area insulated (m²)

 Selection

 Area uninsulated (m²)

Select an orientation

Length (m): length of your pipe or duct in meters

Selection: you can deploy the list and you can choose among these values:

Diameter mm
DN Copper tube, CU DIN EN 1057
DN Steel tube FE DIN EN 10255 (Middle row)
NPS Steel tube

DN and NPS are databases containing the right external diameter for each kind.

Outside diameter (mm): outside diameter of your pipe in millimetres.

Area uninsulated (m²): area around your pipe before increasing the diameter with insulation in square meters

Area insulated (m²): area around your insulation once it is in place in square meters



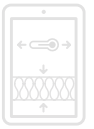

Select an orientation: select the orientation of your pipe

Horizontal indoor
Vertical indoor
Horizontal outdoor
Vertical outdoor
Approximation vertical orientation
Approximation horizontal orientation
free input hse/hle

'free input hse/hle' is the option to use in case outer/inner surface coefficients are known



WALLS:

	<p>Length (m)</p> <input type="text"/>		<p>Height (m)</p> <input type="text"/>
	<p>Area uninsulated (m²)</p> <input type="text"/>		<p>Area insulated (m²)</p> <input type="text"/>
<p>Select an orientation</p>			
<div style="border: 1px solid #ccc; padding: 5px; display: inline-block; background-color: #f0f0f0;"> Horizontal indoor ▼ </div>			
<p>Characteristic length (m)</p>			
<input style="width: 100%;" type="text" value="0"/>			

Length (m): length of your wall in meters

Height (m): height of your wall in meters

Area uninsulated (m²): area around on your wall before increasing the perimeter with insulation in square meters

Area insulated (m²): area around your insulation once it is in place in square meters

Select an orientation: select the orientation of your wall

Select an orientation: select the orientation of your wall

Horizontal indoor
Vertical indoor
Horizontal outdoor
Vertical outdoor
Approximation vertical orientation
Approximation horizontal orientation
free input hse/hie



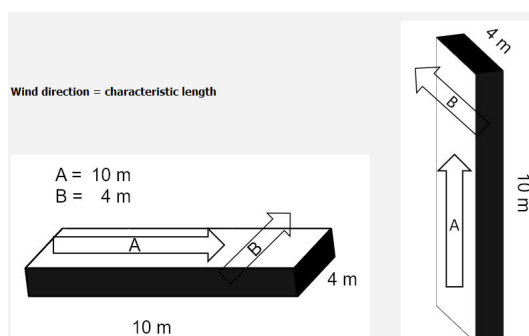

'free input hse/hie' is the option to use in case outer/inner surface coefficients are known

Characteristic length (m): dimension used to calculate convection surface coefficient. It depends on the wind direction. Value pre-set at the maximum value between length and height:





DUCTS:

	Length (m)	<input type="text"/>		Height (m)	<input type="text"/>
	Width (m)	<input type="text"/>		Area uninsulated (m ²)	<input type="text"/>
	Area insulated (m ²)	<input type="text"/>			

Select an orientation

▼

Characteristic length (m)

Length (m): length of your duct in meters

Height (m): height of your duct in meters

Width (m): width of your duct in meters

Area uninsulated (m²): area around your duct before increasing the perimeter with insulation, in square meters

Area insulated (m²): area around your insulation once it is in place in square meters

Select an orientation: select the orientation of your duct

Horizontal indoor
Vertical indoor
Horizontal outdoor
Vertical outdoor
Approximation vertical orientation
Approximation horizontal orientation
free input hse/hle

'free input hse/hle' is the option to use in case outer/inner surface coefficients are known

Characteristic length (m): dimension used to calculate convection surface coefficient. It depends on the wind direction. Value pre-set at the maximum value between length, width and height.

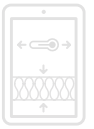

CYLINDRICAL TANKS:



Outside diameter (m)



Height (m)



Area uninsulated (m²)



Area insulated (m²)

Select an orientation

Horizontal indoor ▼

Characteristic length (m)

Insulation on:

Top

Side

Bottom

Outside diameter (m): outside diameter of your tank/vessel in meters.

Height (m): height of your tank/vessel in meters

Area uninsulated (m²): area around your duct before increasing the diameter with insulation in square meters

Area insulated (m²): area around your insulation once it is in place in square meters

Select an orientation: select the orientation of your tank

Horizontal indoor
Vertical indoor
Horizontal outdoor
Vertical outdoor
Approximation vertical orientation
Approximation horizontal orientation
free input hse/hle

'free input hse/hle' is the option to use in case outer/inner surface coefficients are known

Characteristic length (m): dimension used to calculate convection surface coefficient. It depends on the wind direction. Value pre-set at diameter value for horizontal tanks, and height for vertical ones.

Insulation on: You can set what part of your tank is insulated. By defect, the whole tank appears as insulated (three buttons marked (blue colour)).

Top

Side

Bottom



CUBICAL TANKS:



Outside diameter (m)



Height (m)



Area uninsulated (m²)



Area insulated (m²)

Select an orientation

Horizontal indoor ▼

Characteristic length (m)

Insulation on:

Top

Side

Bottom

Length (m): length of your tank/vessel in meters

Height (m): height of your tank/vessel in meters

Width (m): width of your tank/vessel in meters

Area uninsulated (m²): area around your duct before increasing the perimeter with insulation in square meters

Area insulated (m²): area around your insulation once it is in place in square meters

Select an orientation: select the orientation of your tank

Horizontal indoor
Vertical indoor
Horizontal outdoor
Vertical outdoor
Approximation vertical orientation
Approximation horizontal orientation
free input hse/hle

'free input hse/hle' is the option to use in case outer/inner surface coefficients are known

Characteristic length (m): dimension used to calculate convection surface coefficient. It depends on the wind direction. Value pre-set at the maximum value between length, width and height.

Insulation on: You can set what part of your tank is insulated. By defect, the whole tank appears as insulated (three buttons marked (blue colour)).

Top

Side

Bottom

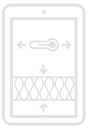

SPHERICAL TANKS:



Outside diameter (m)



Area uninsulated (m²)



Area insulated (m²)

Select an orientation

Horizontal indoor
▼

Characteristic length (m)

Outside diameter (m): outside diameter of your tank/vessel in meters.

Area uninsulated (m²): area around your duct before increasing the diameter with insulation in square meters

Area insulated (m²): area around your insulation once it is in place in square meters

Select an orientation: select the orientation of your tank

Horizontal indoor
Vertical indoor
Horizontal outdoor
Vertical outdoor
Approximation vertical orientation
Approximation horizontal orientation
free input hse/hie

'free input hse/hie' is the option to use in case outer/inner surface coefficients are known

Characteristic length (m): dimension used to calculate convection surface coefficient. It depends on the wind direction. Value pre-set at diameter value.



C2. CALCULATION METHODS

In this second step you will select the calculation method you want to use for your component:

The screenshot shows the TechCalc software interface. The top navigation bar includes steps: 1 Components, 2 Calculation Methods (active), 3 Medium, 4 Climate, 5 Insulation System, Thermal Bridges, Economy, and Results. The main area is titled 'Select a Calculation Method' and lists four options: 'Heat loss/gain and surface temperature' (with a blue icon), 'Minimum insulation thickness' (with a yellow icon), 'Operational costs' (with a clock icon), and 'More' (with a plus icon). On the right, a panel for 'Pipe Component Nr.4' displays details: 'Heat loss/gain and surface temperature', 'Length: 1 m', 'Diameter: 50 mm', 'Orientation: Horizontal indoor', and a 3D model of a pipe. Below the model, it shows 'T-inside: 0 °C', 'T-ambient: 0 °C', and 'Insulation System Version 1'. A warning icon and text 'Please choose a calculation method... read more' are also present. The bottom status bar shows 'TechCalc: v2.0.0.44-db-2.0.0.9 ©2014. All rights reserved. Language: Database Language: Back'.

Depending on the application you are in and the type of component you are working with, you will find different calculation methods. All calculation methods available are:

- » Heat loss/gain and surface temperature
- » Minimum insulation thickness
 - For a maximum heat flow rate
 - For a maximum surface temperature
 - For both, maximum heat flow rate and maximum surface temperature
 - For preventing condensation (outside)
 - For preventing condensation inside
- » Operational cost
- » More
 - Axial temperature decrease of the flowing medium
 - Temperature decrease over the time
 - Moisture accumulation on a cooling component
 - Calculation U-R value
 - Underground component
 - Time it takes for the water inside component to freeze (0°C)
 - Economic cost

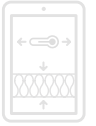

All calculations are done following formulas given in the international standard ISO 12241 / VDI 2055 / ASTM C 680, depending on the choice made. Declared lambda values (λ_d) will be modified following procedures given in ISO 23993 / VDI 2055:

$$\lambda = \lambda_d F + \Delta\lambda$$

$$F = F_{\Delta\theta} F_m F_a F_C F_c F_d F_j$$

For further details, see 'c6 - Thermal bridges'.

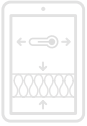

C2-I. HEAT LOSS/GAIN AND SURFACE TEMPERATURE



Heat loss/gain and surface temperature

Within this calculation method you will obtain the heat loss/gain through your system and the surface temperature.

All calculations are done following formulas given in the international standard ISO 12241, chapter 4.

This is the output you will have following this method:

Heatloss	W/m or W/m ²
Heatloss (Area insulated)	W/m ²
Total heatloss	W
T-surface	°C
he-Value	W(m ² k)

Heat loss can be expressed in W/m (for pipes or circular ducts) or in W/m² for the rest of components.

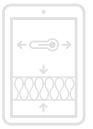

C2-II. MINIMUM INSULATION THICKNESS

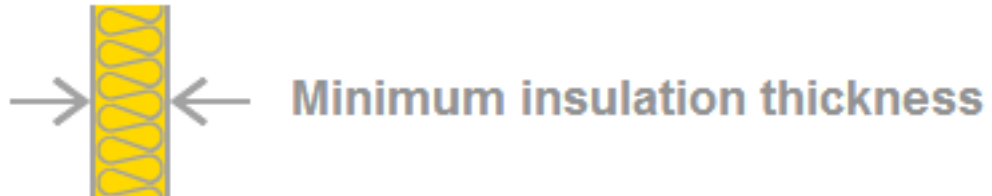

Within this calculation method you will obtain the minimum insulation thickness for the scenario you have created, including your insulation selection. You have up to 5 different choices for calculating the minimum insulation thickness:

- » For a maximum heat flow rate
- » For a maximum surface temperature
- » For both, maximum heat flow rate and maximum surface temperature
- » For preventing condensation (outside)
- » For preventing condensation inside

All calculations are done following formulas given in the international standard ISO 12241, chapter 4.

A) MAXIMUM HEAT FLOW RATE

Within this option, TechCalc will calculate the minimum thickness required to get a determined maximum heat flow.

When selecting this option, you will find a field to fill in, Max. Heat flow rate, in W/m for pipes and circular ducts or in W/m² for the rest of components:

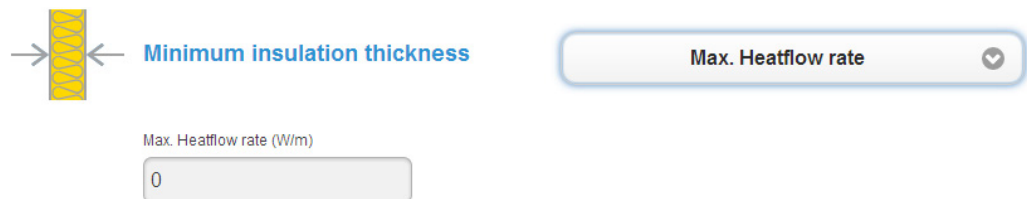

In this field you must set the limit in terms of heat loss you want to have as maximum in your system. As an output you will have the following:

Heatloss	W/m or W/m ²
Heatloss (Area insulated)	W/m ²
Total heatloss	W
T-surface	°C
Min. Thickness	mm
he-Value	W(m ² k)



B) MAXIMUM SURFACE TEMPERATURE

Within this option, TechCalc will calculate the minimum thickness required to get a determined maximum surface temperature.

When selecting this option, you will find a field to fill in, Surface temperature (°C):

In this field you must set the limit in terms surface temperature you want to have as maximum on your cladding or external surface. As an output you will have the following:

→  ← **Minimum insulation thickness** Surface temperature

Surface temperature (°C)

In this field you must set the limit in terms surface temperature you want to have as maximum on your cladding or external surface. As an output you will have the following:

Heatloss	W/m or W/m ²
Heatloss (Area insulated)	W/m ²
Total heatloss	W
T-surface	°C
Min. Thickness	mm
he-Value	W(m ² k)

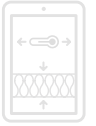

C) BOTH

When selecting this option, you will find two fields to fill in, Max. Heat flow rate (W/m or W/m²) and Surface temperature (°C):

The screenshot shows a yellow vertical bar with a wavy pattern representing insulation, with arrows pointing outwards. To its right is the text 'Minimum insulation thickness'. Further right is a dropdown menu currently set to 'Both'. Below these are two input fields: 'Max. Heatflow rate (W/m)' with the value '0' and 'Surface temperature (° C)' with the value '0'.

In this field you must set the limits in terms of heat loss and surface temperature you want to have as maximum in your system and on your cladding or external surface. TechCalc will calculate the thickness required for the worst scenario, either Max heat flow or Surface temperature.

As an output you will have the following:

Heatloss	W/m or W/m ²
Heatloss (Area insulated)	W/m ²
Total heatloss	W
T-surface	°C
Min. Thickness	mm
he-Value	W(m ² k)



D) PREVENTION CONDENSATION

Within this option, TechCalc will calculate the minimum thickness required to avoid condensation outside the system.

When selecting this option, you will find there are no additional fields to fill in:



However, you will find an additional data is required in the step 4: Climate, the external ambient relative humidity:



As an output you will have the following:

Heatloss	W/m or W/m ²
Heatloss (Area insulated)	W/m ²
Total heatloss	W
T-surface	°C
Min. Thickness	mm
Dewpoint temperature outside	°C
he-Value	W(m ² k)

Note that dew point is calculated.

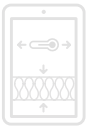

E) PREVENTING CONDENSATION INSIDE

Within this option, TechCalc will calculate the minimum thickness required to avoid condensation inside the system.

When selecting this option, you will find there are no additional fields to fill in:



Using this method you will find a constraint regarding the medium, it can only be air or gas medium. You will find additional data is required in the step 3: Medium for creating a definition of the medium state:

	Relative humidity inside	%
C_p	Heat capacity	kJ/kgK
λ	Conductivity	W/(mK)
ρ	Density	kg/m ³
v	Velocity	m/s

As an output you will have the following:

Heatloss	W/m or W/m ²
Heatloss (Area insulated)	W/m ²
Total heatloss	W
T-surface	°C
Min. Thickness	mm
Dewpoint temperature outside	°C
he-Value	W(m ² k)

Note that dew point is calculated.



C2-III. OPERATIONAL COST

Through this method you will be able to calculate the total energy cost of your system and payback time for the different solutions on your choice.



Operational costs

Within this calculation method two different standards are used: ISO 12241 chapter 4 for thermal calculations and VDI 2055 Part 1, chapter 6 for economic calculations.

When selecting this calculation method you will find that some additional data is required in steps 3, 4, 5 and 7.

In step 3 you will need to fill in the amount of hours that your facility is working per year:

Operational hours

hours

You'll have an available list of most frequent scenarios just clicking in 'free input':

free input
Heating period 185 days *24h, new building (with no reduction in power at night)
Heating period 220 days *24h, renovation (with no reduction in power at night)
Heating period 275 days *24h, old building (with no reduction in power at night)

You can select one from the list or just go for a free input. The value set will influence in the total cost of energy and therefore the payback time.

In step 4 you will find a new field for the kind of energy source you use:

Energy source CO²-Emissions

no selection = kWh/year without CO₂-E... 

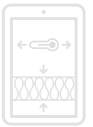

By just clicking on it, you will find a multiple choice list for different energy sources:

no selection = kWh/year without CO2-Emissions
kWh/year electricity mix
liter Oil/year (10 kWh=1 Liter)
m ³ Gas/year (10 kWh=1 m ³)
kg pellets (5 kWh=1 kg)
kg wood (4 kWh=1 kg)
kg anthracite coal (8 kWh= 1 kg)
kg brown coal (6 kWh=1 kg)

You can see, inside the list, the different conversion values used for each energy source. Values will be used for calculating CO2 emissions.

In [step 5](#) you will need to provide a budget for your insulation installation, including all costs (insulation material, installation cost (manpower plus accessories, cranes, scaffolding, etc), transport, etc).





Total costs

EUR

This is the value that will be used, as your total capital investment, for calculating the payback time later on.

Finally, when you select this calculation method, is mandatory to fill in the data required in [step 7: Economy](#):

Currency	
Euro (EUR) 	
Heating system	Energy Efficiency of the heating system (1=100%)
free input 	1
Energy Cost (/kWh)	Actual Energy Cost (/kWh)
0	0

Currency: you can select any currency in the world. Select the one you want just by clicking on it.

Heating system: by choosing one heating system, you are selecting a yield for your energy system. Clicking on it you will find the most common heating systems with their efficiencies:



free input
Condensing therme after 1995
Oil-Single oven
Coal- wood stove
Gas Heater
Electrical night storage heating system until 1994
Electrical night storage heating system after 1995
Electrical direct heating system

Energy Efficiency of the heating system (1=100%): You can fill in with your own yield data or just select one heating system and it will provide you with the right system efficiency figures. Be careful because usually the yield is expressed as the reverse function, so 1/yield.

Energy cost (/kWh): You must fill in the price you are paying for your energy in 'Currency'/kWh. For EU countries it will be in EUR/kWh, as it is selected as default value.

Actual energy cost (/kWh): This is the result of your energy cost and the yield of your system. TechCalc will calculate it automatically.

As an output you will have the following:

Heatloss	W/m or W/m ²
Heatloss (Area insulated)	W/m ²
Total heatloss	W
T-surface	°C
Energy Consumption (7500h)	KWh/a
Operational costs	EUR/a
Insutation costs	EUR
Payback time	a
Co ₂ emission	Kg/a
he-Value	W(m ² k)

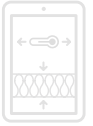

C2-IV. OTHERS: AXIAL TEMPERATURE DECREASE OF THE FLOWING MEDIUM

With this method you will calculate the temperature drop in your medium between the beginning and the end of your pipe or duct.



More

Axial temperature decrease of the flowing medium

All calculations are done following formulas given in the international standard ISO 12241, chapter 5.1.

In the step 3 you will have to fill in additional data:

\overline{P}	Pressure	Bar
$\overline{C\rho}$	Heat capacity	kJ/kgK
$\overline{\lambda}$	Conductivity	W/(mK)
$\overline{\rho}$	Density	kg/m ³
\overline{v}	Velocity	m/s

For liquid mediums or water steam, you will have the possibility of including the flow, either in Kg/h (mass flow rate) or in m³/h (volume flow rate), instead of the medium velocity:

Mass flow rate(kg/h)

Volume flow rate(m³/h)

30211200

28800

If you use the velocity field, flow rates will be automatically calculated by TechCalc.

As an output you will have the following:

Heatloss	W/m or W/m ²
Heatloss (Area insulated)	W/m ²
Total heatloss	W
T-surface	°C
axial temp. decrease	°C
he-Value	W/(m ² k)



C2-V. OTHERS: TEMPERATURE DECREASE OVER THE TIME

With this method you will calculate the temperature drop in your medium after a certain amount of time (minutes)



More

Temperature decrease over time



In the step 3 you will have to fill in additional data:

	Standstill period	min
P	Pressure	Bar
C_p	Heat capacity	kJ/kgK
λ	Conductivity	W/(mK)
ρ	Density	kg/m ³
$V\%$	Volume percentage	%

For liquid mediums or water steam, you will have the possibility of including the flow, either in Kg/h (mass flow rate) or in m³/h (volume flow rate), instead of the medium velocity:

Mass flow rate(kg/h)

Volume flow rate(m³/h)

30211200

28800

If you use the velocity field, flow rates will be automatically calculated by TechCalc.

As an output you will have the following:

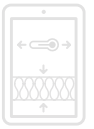

Heatloss	W/m or W/m ²
Heatloss (Area insulated)	W/m ²
Total heatloss	W
T-surface	°C
Temperature change in 7000 minutes	°C
he-Value	W(m ² k)



C2-VI. OTHERS: MOISTURE ACCUMULATION IN A COOLING COMPONENT

With this method you will calculate the amount of moisture ingress in the system due to water vapour diffusion effect in your insulation system (sd and μ values).



More

Moisture accumulation on a cooling component



All calculations are done following formulas given in the German standards VDI 2055, chapter 5.3 and AGI Q 112.

In the step 3 you will have to fill in additional data:



Operational hours

free input

7500

hours/ly



Relative humidity inside

In the step 4 you will have to fill in additional data also:



Relative humidity outside %

As an output you will have the following:

Heatloss	W/m or W/m ²
Heatloss (Area insulated)	W/m ²
Total heatloss	W
T-surface	°C
Moisture accumulation rate(VDI)	kg/m
Moisture accumulation rate(AGI 112)	kg/m ³
he-Value	W(m ² k)

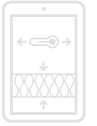

C2-VII. OTHERS: CALCULATION

U-R VALUE

With this method you will calculate U and R values.

R: Thermal Resistance of insulating material. Formula used: $R = d/\lambda$ (m²K/W)

U: Thermal Transmittance of the insulation system. Formula used: $U = 1/((1/h_i)+R+(1/h_e))$ (W/m²K)



More

Calculation U- R- value



All calculations are done following formulas given in the International standard ISO 12241, chapter 4.

As an output you will have the following

Heatloss	W/m or W/m ²
Heatloss (Area insulated)	W/m ²
Total heatloss	W
U-Value	W/(mk)
R-Value	mK/W
T-surface	°C
he-Value	W(m ² k)



C2-VIII. OTHERS: UNDERGROUND COMPONENT

With this method you will calculate heat loss and the surface temperature in an underground pipe (this method is only available for pipes. Tanks are excluded). The only scenario covered with this function is the case of a single line without channels.



More

Underground component



All calculations are done following formulas given in the International standard ISO 12241, chapter 8.

Ground temperature	°C
Depth	m
Ground thermal conductivity	W/(mk)
Backfill	m

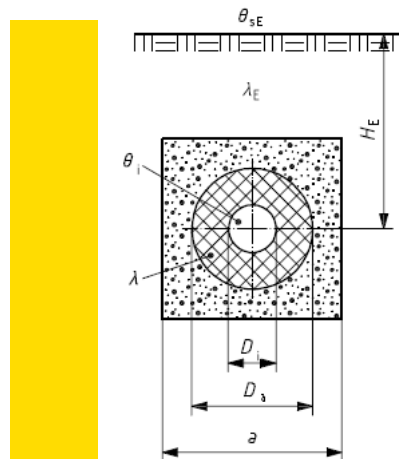

Ground Temperature (°C): Surface temperature of the soil. θ_{sE} in the drawing

Depth (m): Distance from the ground limit to the centre of the pipe line. Dimension H_E in the drawing

Ground thermal conductivity (W/mK): Thermal conductivity of the ambient soil. λ_E in the drawing

Backfill (m): Dimension a in the drawing

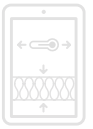

As an output you will have the following:

Heatloss	W/m or W/m ²
Heatloss (Area insulated)	W/m ²
Total heatloss	W
T-surface	°C

Note.- In the case of commonly used jacket pipes that are laid adjacent to each other, if $\lambda \ll E$, calculation as a single pipe is generally sufficient as an initial approach, as heat interchange between the pipes can be disregarded. Simplified calculation is not permissible for pipes embedded in insulating masses without additional insulation.



C2-IX. OTHERS: TIME IT TAKES FOR THE WATER INSIDE COMPONENT TO FREEZE (0°C)

With this method TechCalc will calculate the time it takes the water inside a component to get freeze, at 0°C. This calculation method is only available for pipes.



More

Time it takes for the water inside component to freeze (0°C) 

All calculations are done following formulas given in the international standard ISO 12241, chapter 6.

In the step 3 you will notice that you cannot set a temperature inside your pipe because it is pre-set to 0°C. You will have to provide additional data:



Ice formation

0

%

Ice formation (%): This value represents the total amount of water volume that will become ice inside your pipe.

As an output you will have the following:

Heatloss	W/m or W/m ²
Heatloss (Area insulated)	W/m ²
Total heatloss	W
T-surface	°C
Freezing Time	min
he-Value	W(m ² k)

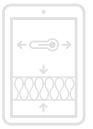

C2-X. OTHERS: ECONOMIC COST

With this method TechCalc will calculate the economy chart based on insulation thickness vs total cost (energy plus insulation system). The aim of this chart is searching the economic thickness and/or the energy efficiency thickness.

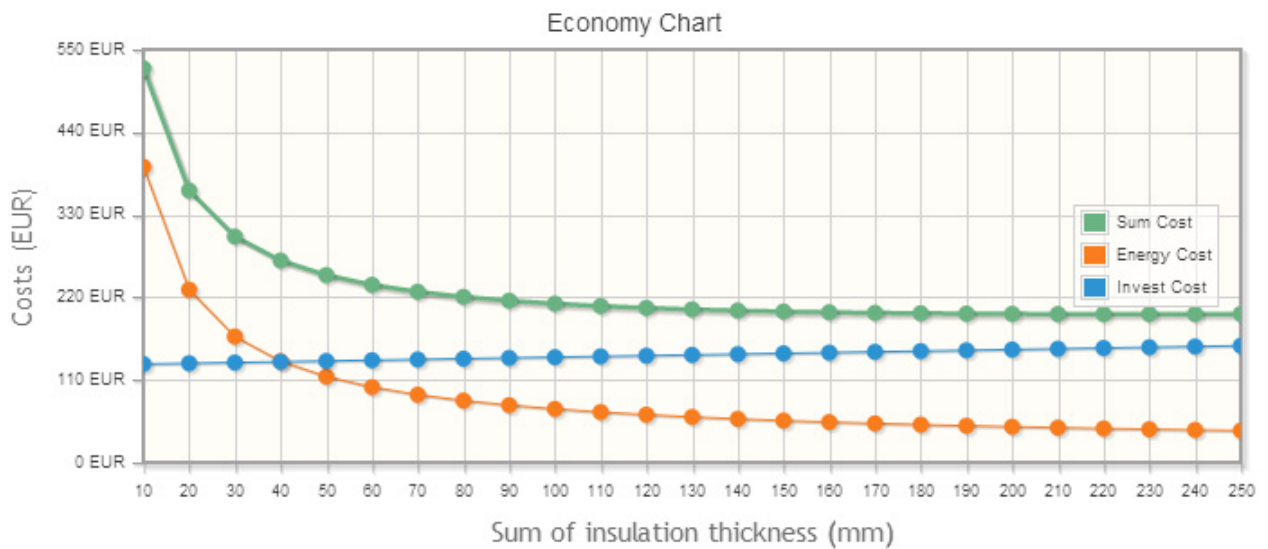

All calculations are done following formulas given in the German standard VDI 2055, chapter 6.

In step 3 you will need to fill in the amount of hours that your facility is working per year:



Operational hours

free input

7500

hours/y

You'll have an available list of most frequent scenarios just clicking in 'free input':

free input

Heating period 185 days *24h, new building (with no reduction in power at night)

Heating period 220 days *24h, renovation (with no reduction in power at night)

Heating period 275 days *24h, old building (with no reduction in power at night)

You can select one from the list or just go for a free input. The value set will influence in the total cost of energy.



When you select this calculation method, it is mandatory to fill in the data required in [step Z](#): Economy:

Currency		Euro (EUR)			
Heating system	Gas Heater	Energy Efficiency of the heating system (1=100%)	1.47		
Energy Cost (/kWh)	0,037	Actual Energy Cost (/kWh)	0.05		
Expected service life for years (a)	20	Annual price variation (%)	2		
Interest rate (%)	2	Maintenance (%)	2		
General cost (%)	3				
Cladding material cost (EUR)		Cladding installation cost (EUR)			
150		1000			
Insulation outside					
Nr.	Name	Min.Thickness (mm)	Max.Thickness (mm)	Basic cost (EUR/m ²)	Thickness cost (EUR/m)
1	TECH Pipe Section MT 4.0	10	250	20	912,8

Currency: you can select any currency in the world. Select the one you want just by clicking on it.

Heating system: by choosing one heating system, you are selecting a yield for your energy system. Clicking on it you will find the most common heating systems with their efficiencies:

Energy Efficiency of the heating system (1=100%): You can fill in with your own yield data or just select one heating system and it will provide you with the right system efficiency figures. Be careful because usually the yield is expressed as the reverse function, so 1/yield.

Energy cost (/kWh): You must fill in the price you are paying for your energy in 'Currency'/kWh. For EU countries it will be in EUR/kWh, as it is selected as default value.

Actual energy cost (/kWh): This is the result of your energy cost and the yield of your system. TechCalc will calculate it automatically.

Annual price variation (%): The difference between the actual and future prices of your insulation system.

Expected service life (y): It is the time that the machine or facility is expected to be working, in years

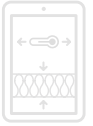

Interest rate (%): the interest percent that a bank or other financial company charges you when you borrow to invest in your insulation system.

Maintenance (%): The amount of money invested in maintenance of your insulation system along its service life compared with the total amount of the investment.

General cost (%): The amount of money expended related to your insulation system (maintenance excluded) along its service life compared with the total amount of the investment.

Cladding material cost (Currency): Cladding total cost in your insulation system for your machine or installation.

Cladding installation cost (Currency): Total cost of installing the cladding of your insulation system in your machine or installation.

Insulation outside:

Nr.	Name	Min.Thickness (mm)	Max.Thickness (mm)	Basic cost (EUR/m ²)	Thickness cost (EUR/m)
1	TECH Pipe Section MT 4.0	<input type="text" value="0"/>	<input type="text" value="0"/>	<input type="text" value="0"/>	<input type="text" value="0"/>

Min. and Max. Thickness (mm): Through these two values we define the thickness range.

Basic cost (Currency/m²): Insulation installed cost by m².

Thickness cost (Currency/m): Price for one meter thickness insulation of the selected material.

As an output you will have the following:

Heatloss	W/m or W/m ²
Heatloss (Area insulated)	W/m ²
Total heatloss	W
T-surface	°C
he-Value	W/(m ² K)

And the graph:

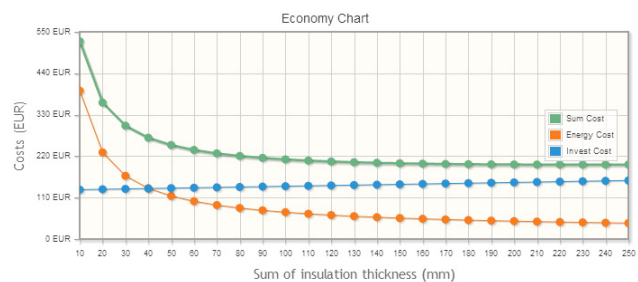



C3. MEDIUM

In this step you will fill in all the data related to the medium inside your component. By default TechCalc will show a 'standard' fluid (hi, internal surface coefficient, is neglected).

For choosing a different medium, just click in the \oplus symbol. You will access to different mediums:

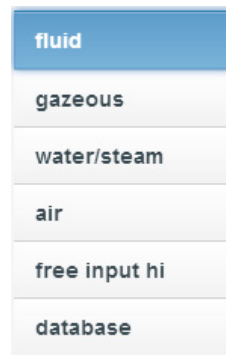

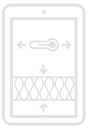

If you select 'database' you'll access to the mediums database, where you will find different liquid and gaseous mediums:

You can select from the 'Catalogs' (1) first the kind of medium (liquid or gas) and then select from the 'Mediums' list (2) the medium you want. On the right you have medium information (3). Once the medium has been selected, click on



This step changes the input fields depending on the calculation method and of course the kind of medium selected. The fields you can find in this step 3 are the followings:

Operational hours		free input	7500	hours/y
	Relative humidity inside		%	
C_p	Heat capacity		kJ/kgK	
λ	Conductivity		W/(mK)	
ρ	Density		kg/m ³	
v	Velocity		m/s	
P	Pressure		Bar	
	Standstill period		min	
$V\%$	Volume percentage		%	
	Ice formation		%	

You will find the explanation relative to each parameter along the chapter 'c.2'. An explanation is given only for those parameters not purely physics, as it could be density, heat capacity, etc.



C4. CLIMATE

In this step you will fill in all the data related to the ambient conditions outside your component. If your component is 'indoor', so no wind or low speed wind ($\leq 2\text{m/s}$), you will have to fill in just the outside temperature:



Ambient temperature

°C

In case of having an 'outdoor' component (wind speed $> 2\text{ m/s}$) you will need to fill in the wind speed also:



Wind

m/s

Other parameters could be needed in this step depending on the calculation method selected:



Relative humidity outside %

Energy source CO₂-Emissions

no selection = kWh/year without CO₂-E... 

Ground temperature	°C
Depth	m
Ground thermal conductivity	W/(mk)
Backfill	m

You have access to a database of climate conditions, either 'indoor' conditions or local areas or cities, depending on the 'database language' (see chapter 'e3 - Database access and manage').

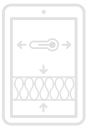

To access the database to select a climate condition you just need to click on this icon:



Database

After clicking on this icon you will find:

a) Indoor catalogue:

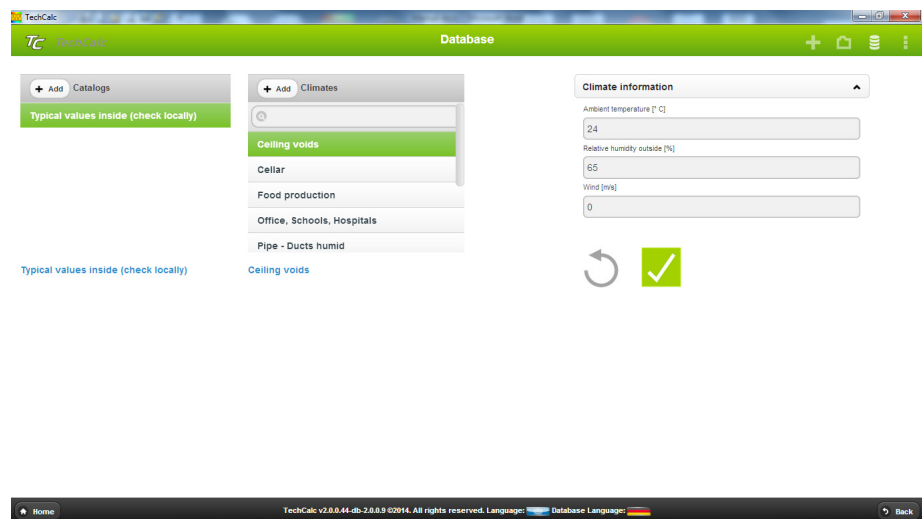

b) Local Climatic conditions in the local database selected:

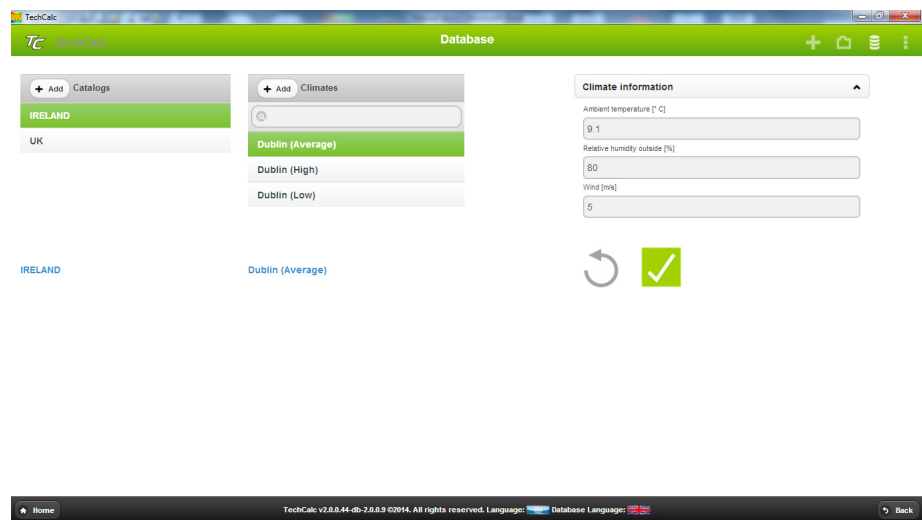

After selecting a climate condition, just click on 



C5. INSULATION SYSTEM

In this step you will define your insulation system. There are up to 4 different parts in your insulation system:

- » Cladding
- » Insulation outside
- » Wall
- » Insulation inside

Cladding

This is the area of your screen dedicated to the cladding:

Database	1 Cladding	Aluminio, oxidado	€ 0.13
	2 Uninsulated ε		0.8

- 1** Cladding proposed for your system
- 2** Wall of your component without insulation and without cladding

For the cladding proposed in your system, **1**, you can either introduce an emissivity value (ε) directly on the field or select it from the database (Database). If you click on the database option, you will find the list of different claddings, with their technical values, as they are in ISO 12241:

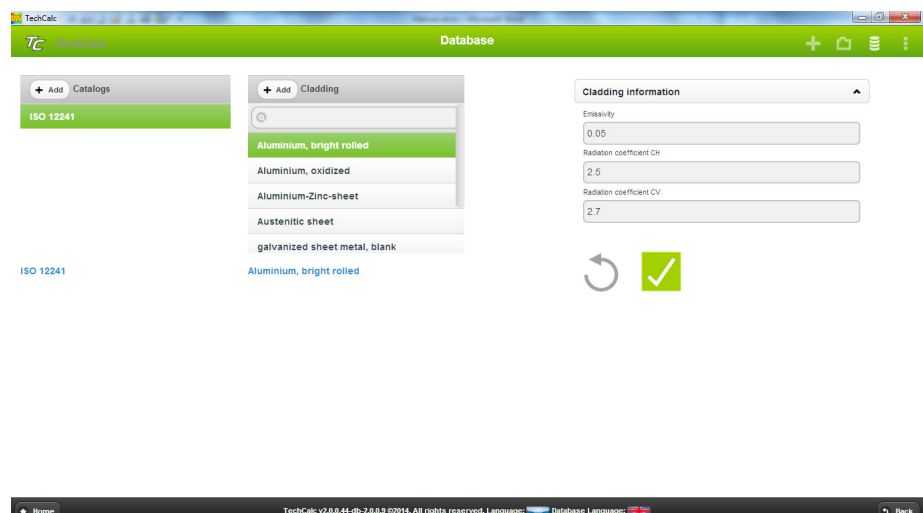

After selecting selecting a cladding, just click on

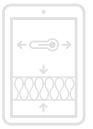

For setting an emissivity value for the bare wall of your component, you only have the possibility of introducing it in the field **2**. This value will be used by TechCalc to calculate the heat loss of your system before putting any kind of insulation or cladding. By default, TechCalc gives you a value of 0,8, steel emissivity.

INSULATION OUTSIDE

By this you will define the insulation you will place in the external face of your component's wall. This option is always available, for any calculation method or component.

This is the area of your screen dedicated to Insulation outside:

1 + **Insulation outside**

Copy	Remove	Nr.	2 Name	3 Thickness [mm]	5 <input type="checkbox"/> λ_{av}
4		1 6	PI-156 DRA NAVAL	100	<input type="checkbox"/> λ_{av}
		2	PI-156 DRA NAVAL	100	<input type="checkbox"/> λ_{av}

- 1** This '+' symbol is used to add one layer on insulation
- 2** Insulation material choice
- 3** Thickness for each layer
- 4** Edition tools:
 - Copy layer
 - Delete layer
- 5** Selection for insulation materials tested under ISO 8497 standard (cylindrical)
- 6** Layers order



After clicking on the '+' symbol you will arrive to the material selection place in the database:

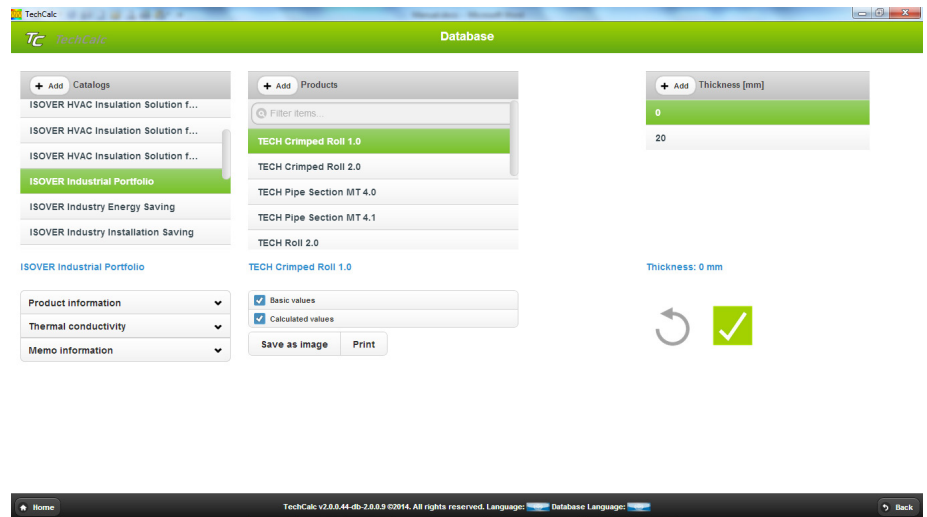

You select first your 'Catalogue' and then you can select the exact product you want to use. Later on you can select the thickness in this screen or you can place it directly in the thickness field later on. By selecting a thickness from the thickness list you will be sure about the thickness selected is a commercial one you can find in the market. Remember always clicking on  after making your choice.

Once you have accomplished this material selection it will appear in your 'Insulation outside' area:

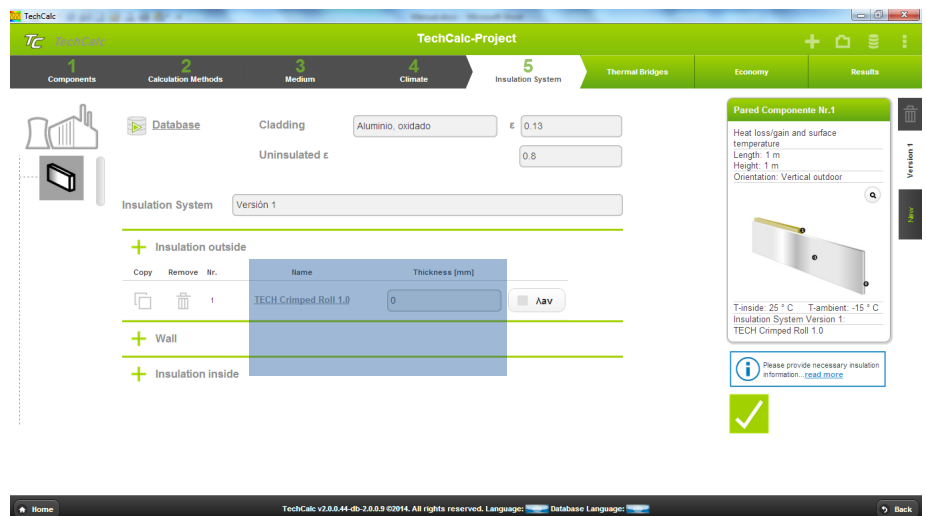

Now, as said before, you can set your insulation thickness or modify the previous one directly on the thickness field.

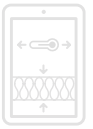

You could add a new insulation layer by just repeating the same steps: clicking on '+' symbol, selecting the material from the database and setting the thickness. You can add up to 10 layers, with no limitation in the total thickness. You can also copy a previously existing layer, with all its attributes, by just clicking on . For deleting an existing layer you just have to click on



WALL

Defining a wall is optional. Usually component walls are not affecting too much to the final results since wall materials conductivities use to be very high and thickness small. It is only required with 'Insulation inside' option.

The steps to follow for defining a wall are exactly the same than for the 'Insulation outside'.

INSULATION INSIDE

Insulation inside is optional. Usually the insulation inside is just used for some air conditioning ducts. If you select to put some insulation inside you will need to define the wall of your component.

The steps to follow for defining insulation inside are exactly the same than for the 'Insulation outside'.

ΔAV

This box must only be marked in case of using products whose declared lambda curve has built up following ISO 8497 standard, for cylindrical shapes (Pipe Sections).

As stated in ISO 23993, chapter 7.2:

"If the design thermal conductivity is needed at another mean temperature than that of the declared thermal conductivity and with another temperature difference, the procedures outlined above shall be followed successively. As an alternative, the influence of the non-linearity of the thermal conductivity curve may be taken into account by integrating the measured curve as given by Equation:

$$\bar{\lambda} = \frac{1}{\theta_2 - \theta_1} \int_{\theta_1}^{\theta_2} \lambda(\theta) d\theta$$



You could add a new insulation layer by just repeating the same steps: clicking on '+' symbol, selecting the material from the database and setting the thickness. You can add up to 10 layers, with no limitation in the total thickness. You can also copy a previously existing layer, with all its attributes, by just clicking on does by default, but it is not the case for Pipe Sections (ISO 8497), where lambda value ($\lambda(\theta_m)$) does not need any kind of correction over declared values.

Flat products $\lambda(\theta) = a_0 + a_1 \cdot \theta + a_2 \cdot \theta^2 + a_3 \cdot \theta^3$ VDI 2055 (eq.4)

Pipes $\lambda(\theta_m) = a_0 + a_1 \cdot \theta_m + a_2 \cdot \theta_m^2 + a_3 \cdot \theta_m^3$

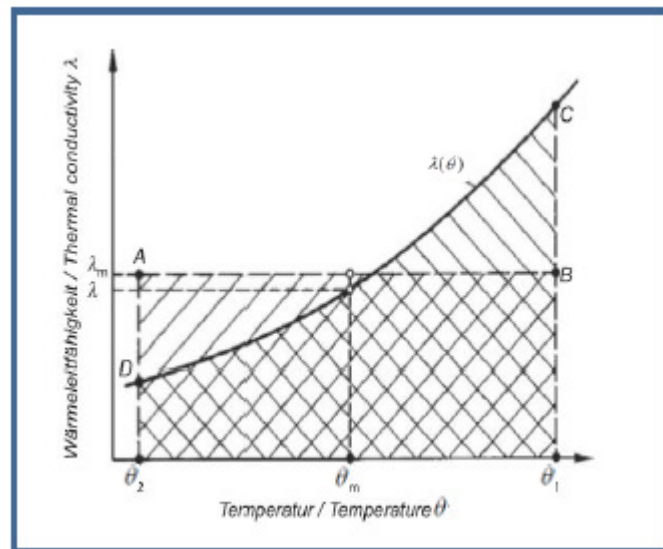
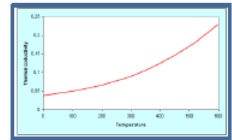

Example for ISO 8497 and ISO 12667 products:

ISO 8497:	1	TECH Pipe Section MT 4.1	<input type="text" value="50"/>	<input checked="" type="checkbox"/> λ_{av}
ISO 12667:	1	TECH Wired Mat MT 5.1	<input type="text" value="50"/>	<input type="checkbox"/> λ_{av}

RESULTS COMPARISON BETWEEN DIFFERENT INSULATION SYSTEMS

Once you have defined your insulation system, you can compare it with other insulation system under the same scenario (component, medium, climate) for comparing results.

You can define up to 5 different insulation systems per component. The aim of defining more than one insulation system is to give you the possibility of comparing, at a glance, results for each of them afterwards.

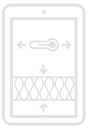

The way for creating a new insulation system inside a selected component is clicking on 'New' on the right 'versions' strip on the right side of your screen:

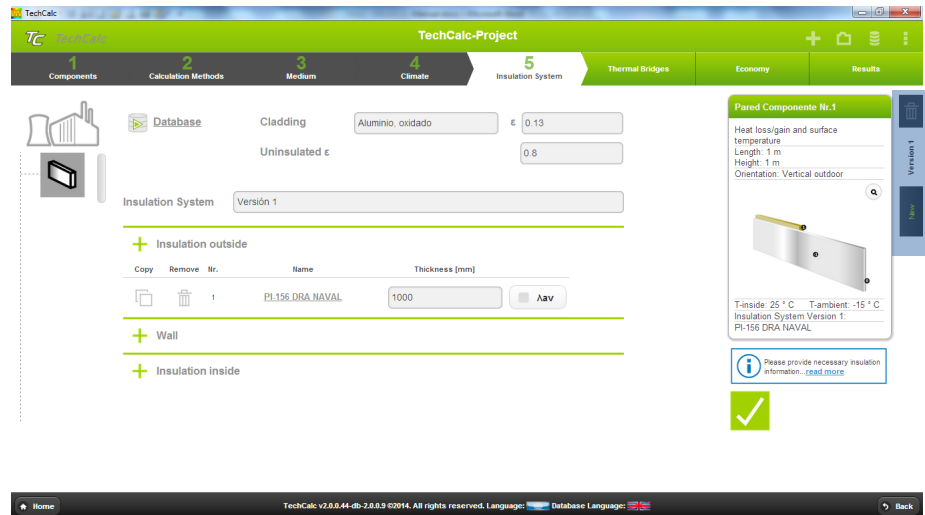

After clicking on 'New', a new insulation version will appear with all the data concerning to the insulation (outside, wall and inside) empty for defining the new insulation system ('version') to be compared with the previous one

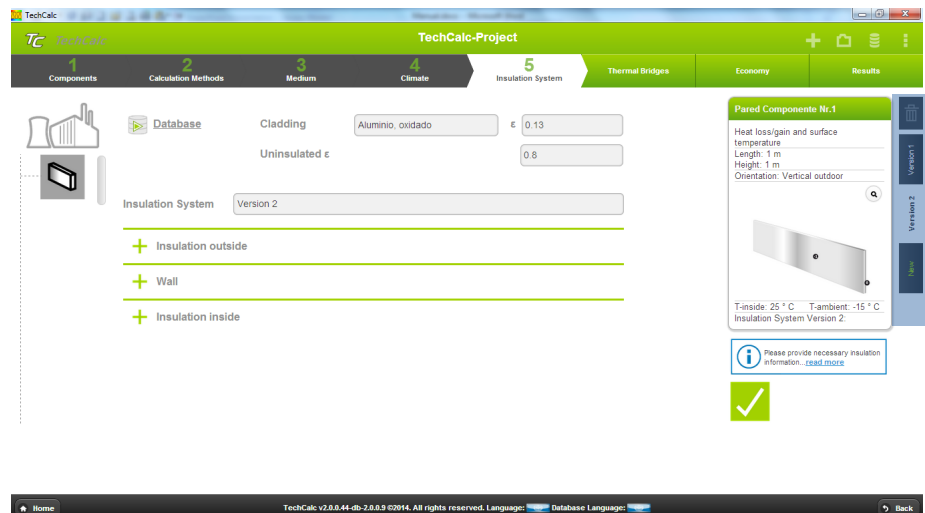

For deleting an existing insulation system 'version', just click on  allocated on top of the 'version' number.



You have the possibility of naming each of your system for having a clearer output and for making easier the navigation through different results:

The screenshot shows the TechCalc software interface. The main window is titled 'TechCalc-Project' and has a navigation bar with tabs: 1 Components, 2 Calculation Methods, 3 Medium, 4 Climate, 5 Insulation System, Thermal Bridges, Economy, and Results. The 'Insulation System' tab is active. On the left, there is a sidebar with icons for 'Database' and 'Insulation System'. The main area shows the configuration for 'Insulation System' with a dropdown menu set to 'Version 2'. Below this, there are three expandable sections: '+ Insulation outside', '+ Wall', and '+ Insulation inside'. On the right, a sidebar titled 'Pared Componente Nr.1' displays a 3D model of a wall component and its technical details: Heat loss/gain and surface temperature, Length: 1 m, Height: 1 m, Orientation: Vertical outdoor. Below the model, it shows 'T.inside: 25 °C', 'T.ambient: -15 °C', and 'Insulation System Version 2'. A green checkmark is visible at the bottom right of the sidebar.

See on the next picture how the name has been modified by just writing the name you desire inside the 'Insulation System' field:

The screenshot shows the TechCalc software interface, similar to the previous one. The 'Insulation System' dropdown menu is now set to 'Wired Net Mat insulation (Energy class 5)'. Below the dropdown, there is a table with columns for 'Copy', 'Remove', 'Nr.', 'Name', and 'Thickness [mm]'. The table contains one row: '1', 'TECH.Wired.Mat.MT.5.1', and '50'. There is also a 'Lay' button next to the thickness field. The right sidebar 'Pared Componente Nr.1' now shows a 3D model of the 'Wired Net Mat' insulation system and its technical details, including 'Insulation System Version 2' and 'TECH Wired Mat MT 5.1'. A green checkmark is visible at the bottom right of the sidebar.

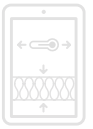

C6. THERMAL BRIDGES (OPTIONAL)

This step is totally linked to what is stated in ISO 23993 (Thermal insulation products for building equipment and industrial installations – Determination of design thermal conductivity) and in VDI 2055-part1: 4.2.1.1 c) operational thermal conductivity (design value). The aim of this ISO standard is determine the lambda value in real design conditions, what are quite different to the conditions existing in the lab when the tests carried out for declaring lambda values were done. VDI has the same aim in the mentioned chapter.

For obtaining this lambda design value, that will be the one used in the calculations, TechCalc has the options of setting all the factors included in ISO 23993 and VDI 2055 that are affecting to the lambda design value:

Symbol	Quantity	Unit
F	overall conversion factor for thermal conductivity	—
F_a	ageing conversion factor	—
F_C	compression conversion factor	—
F_c	convection conversion factor	—
F_d	thickness conversion factor	—
f_d	thickness conversion coefficient	—
F_j	joint factor	—
F_m	moisture conversion factor	—
$\Delta\lambda$	additional thermal conductivity due to thermal bridges, such as spacers, which are regular parts of the insulation	W/(m·K)
$\Delta\lambda_{sq}$	thermal conductivity per spacer per square metre	W/(m·K)

$$\lambda = \lambda_d F + \Delta\lambda$$

$$F = F_{\Delta\theta} F_m F_a F_C F_c F_d F_j$$

$F_{\Delta\theta}$ doesn't need to be introduced in this step because TechCalc is always integrating (except if λ_m is selected) and there is no need to calculate a temperature difference conversion factor.

Even though this calculation step is optional, it is highly recommended to use it for real purpose calculations. Otherwise results could be really different due to the lack of correction when using directly the lambda values declared by the insulation manufacturer.

Before starting with this step 6, the step 5 needs to be finished because all calculations linked with the modification on declared lambda values will be based in the insulation system definition.



For having access to this step you need to click on the marked area (Thermal Bridges):

TechCalc-Project

1 Components 2 Calculation Methods 3 Medium 4 Climate 5 Insulation System Thermal Bridges Economy Results

Database Cladding Aluminio, oxidado ϵ 0.13
Uninsulated ϵ 0.8

Insulation System Wired Net Mat insulation (Energy class 5)

+ Insulation outside

Copy	Remove	Nr.	Name	Thickness [mm]	lav
		1	TECH Wired Mat MT 5.1	50	<input type="checkbox"/>

+ Wall

+ Insulation inside

Pared Componente Nr.1
Heat loss/gain and surface temperature
Length: 1 m
Height: 1 m
Orientation: Vertical outdoor

T-inside: 25 °C T-ambient: -15 °C
Insulation System Version 2:
TECH Wired Mat MT 5.1

Please provide necessary insulation information - [read more](#)

Home TechCalc v2.0.0.44-dt-2.0.0.9 ©2014. All rights reserved. Language: Database Language: Back

Once you click on it, you'll arrive to this screen:

TechCalc-Project

1 Components 2 Calculation Methods 3 Medium 4 Climate 5 Insulation System Thermal Bridges Economy Results

Name:

Hanging + 3

Insulation outside

Nr.	Name	F 1	$\Delta\lambda$ 2
1	TECH Wired Mat MT 5.1	1.133	0.004

Pared Componente Nr.1
Heat loss/gain and surface temperature
Length: 1 m
Height: 1 m
Orientation: Vertical outdoor

T-inside: 25 °C T-ambient: -15 °C
Insulation System Version 2:
TECH Wired Mat MT 5.1

Please provide necessary thermal bridge information - [read more](#)

Home TechCalc v2.0.0.44-dt-2.0.0.9 ©2014. All rights reserved. Language: Database Language: Back

- 1 F factor
- 2 $\Delta\lambda$ factor (real thermal bridges)
- 3 Hangers

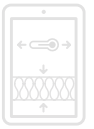

F FACTOR

To define the F factor variables, you need to click on:

After clicking on this 'pencil' symbol, you'll arrive to this screen:

Here you have to choose between:

- » Direct input: you can set directly the F factor value
- » Detailed: you can set the values for each factor

If you choose 'Detailed' you will get this screen:



For setting the 'joint factor' you can choose one of the three options corresponding to your real system:

- » One layer: $F_j = 1,1$
- » Two layers: $F_j = 1,05$
- » Three and more layers: $F_j = 1$

For the rest of the factors you can set the value manually depending on your calculations (out of TechCalc's scope. See ISO 23993 / VDI 2055 for further details).

$\Delta\Delta$ FACTOR

To select the thermal bridges of your system click on:

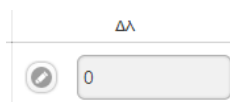

After clicking on this 'pencil' symbol, you'll arrive to this screen:

Mode:				
Direct input		Database		
Name	Quantity	$\Delta\Delta$ [W/(mk)]	Add	
<input type="text"/>	1	<input type="text"/>	+	
Sum of the thermal conductivity supplementary values (*)				
<input type="text" value="0"/>				
Cancel		OK		

Here you have to choose between:

- » Direct input: you can set directly the $\Delta\Delta$ value for different thermal bridges
- » Database: you can select the value from TechCalc database of thermal bridges

If you choose 'Direct input' Just give a name to the thermal bridge you want to create, specify the amount of them per linear meter (pipes or circular ducts) or per square meter (walls, rectangular ducts and tanks with any shape. After clicking in the $\Delta\Delta$ symbol you will add the thermal bridge for calculation and it will appear in your list:

Mode:				
Direct input		Database		
Name	Quantity	$\Delta\Delta$ [W/(mk)]	Add	
<input type="text" value="My thermal bridge_example"/>	1	<input type="text" value="0.009"/>	+	
Thermal conductivity additional values				
Name	Area [m²] Length [m]	Quantity	$\Delta\Delta$ [W/(mk)]	Delete
My thermal bridge_example	<input type="text" value="1"/>	<input type="text" value="1"/>	<input type="text" value="0.009"/>	-
Sum of the thermal conductivity supplementary values (*)				
<input type="text" value="0.009"/>				
Cancel		OK		

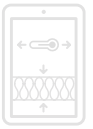

If you would select the 'Database' option, you will access to this screen:

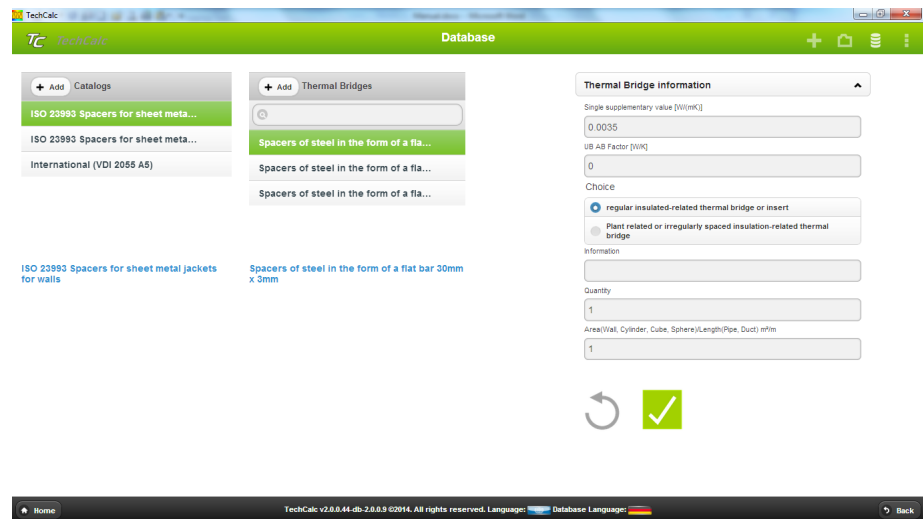

Inside the 'Catalogue' area you will find three different catalogues:

- » ISO 23993 for wall jackets
- » ISO 23993 for pipeline jackets
- » VDI2055 for any kind of component

TechCalc's database of thermal bridges provide you with the values stated in these two well-known Standards.

Select first the catalogue you want to use and later on the kind of spacer you have in your system. Once you have selected the one you will use, just click on  and the thermal bridge will be added to your list.



Mode:

Direct input Database

Name	Quantity	$\Delta\lambda$ [W/(mk)]	Add
<input type="text"/>	1	<input type="text"/>	+

Thermal conductivity additional values

1	Name	Area [m ²]/Length [m]	Quantity	$\Delta\lambda$ [W/(mk)]	Delete
	My thermal bridge_example	1	1	0,009	
	Spacers of steel in the form of a flat bar 40mm x 4mm	1	1	0,006	

Sum of the thermal conductivity supplementary values (*)

0.015 2

Cancel OK

- 1 Your thermal bridges list
- 2 Total value as a result of your thermal bridge definition

Hangers:

There is another kind of thermal bridge you can add out of the standard $\Delta\lambda$ definition: hanging system. This is only available for pipes or circular ducts.

For selecting a hanging system, just click on the + on the right of the word 'Hanging':

Hanging +

Insulation outside

Nr.	Name	F	$\Delta\lambda$
1	TECH Pipe Section MT 4.1	<input type="text" value="1"/>	<input type="text" value="0"/>

Again, you will arrive to a selection screen where you will be able to choose the method you want to use:

- » Equivalent length (for adding elements as valves, flanges, etc.)
- » Pipe hanger global

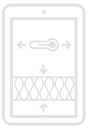

Thermal Bridge Mode

Pipe equivalent length
 Pipe hanger global

Name	Equivalent length (m)	Pipe length	Quantity	Factor z ^x (1=100%)
		12	1	

You will have guidance by clicking in the 'ISO 12241 Table A.1 (pdf)', where you will find a list of equivalent lengths for different scenarios:

Table A.1 — Equivalent length for installation-related “thermal bridges”

Flanges for pressure stages PN 25 to PN 100 ^b			Equivalent length for given temperatures ^a		
			ΔT m		
			100 °C	250 °C	450 °C
Uninsulated for pipes	in buildings at 20 °C	DN 50 °	3 to 5	5 to 11	9 to 15
		DN 100	4 to 7	7 to 16	13 to 16
		DN 150	4 to 9	7 to 17	17 to 30
		DN 200	5 to 11	10 to 26	20 to 37
		DN 300	6 to 16	12 to 37	25 to 57
		DN 400	9 to 16	15 to 36	33 to 56
	in the open air at 0 °C	DN 50	7 to 11	9 to 16	12 to 19
		DN 100	9 to 14	13 to 23	18 to 28
		DN 150	11 to 18	14 to 29	22 to 37
		DN 200	13 to 24	18 to 38	27 to 46
		DN 300	16 to 32	21 to 54	32 to 69
		DN 400	22 to 31	28 to 53	44 to 68
Insulated	in buildings at 20 °C and in the open air at 0 °C	DN 50 °	0,7 to 1,0	0,7 to 1,0	1,0 to 1,1
		DN 100	0,7 to 1,0	0,8 to 1,2	1,1 to 1,4
		DN 150	0,8 to 1,1	0,8 to 1,3	1,3 to 1,6
		DN 200	0,8 to 1,3	0,9 to 1,4	1,3 to 1,7
		DN 300	0,8 to 1,4	1,0 to 1,6	1,4 to 1,9
		DN 400	1,0 to 1,4	1,1 to 1,6	1,6 to 1,9
		DN 500	1,1 to 1,3	1,1 to 1,6	1,6 to 1,8

In addition to this you can select, as well, the kind of 'hanging system' you have (indoor or outdoor) by just selecting 'Pipe hanger global'. In this case, after clicking on this option you will have this screen:

Thermal Bridge Mode

Pipe equivalent length
 Pipe hanger global

Hanger global selection

Indoor pipe hanger
 Outdoor pipe hanger
 Direct input

Factor z^x

(1=100%)



You can set a free value for the Z_x factor ('Direct input') or select between one of the two options given in the ISO 12241 / VDI 2055 A14:

Pipe suspensions	Supplementary value y'
In buildings	0,15
In the open air	0,25

You can add as many items as you need. They will be saved in your calculation and you will have access to any of them through the 'hanging' list:

The screenshot displays the TechCalc software interface for 'Thermal Bridges'. The navigation bar shows steps 1 (Components), 2 (Calculation Methods), 3 (Medium), 4 (Climate), and 5 (Insulation System). The 'Thermal Bridges' section is active, showing a 'Name' input field and a 'Hanging' list. The 'Hanging' list contains two items:

Nr.	Type of thermal bridge	Quantity	Value	Remove
1	Valve	10	1,3	
2	Outdoor pipe hanger	1	0,25	

Below the 'Hanging' list is the 'Insulation outside' section with a table:

Nr.	Name	F	$\Delta\lambda$
1	TECH Pipe Section MT 4.1	<input type="checkbox"/>	<input type="checkbox"/>

On the right, the 'Pipe Component Nr:2' panel shows details for a pipe component:

- Heat loss/gain and surface temperature
- Length: 12 m | Diameter: 543 mm
- Orientation: Horizontal indoor
- T_{inside}: 345 °C | T_{ambient}: 22 °C
- Insulation System Version 1: TECH Pipe Section MT 4.1

A green checkmark icon is visible at the bottom right of the interface.

C7. ECONOMY (OPTIONAL)

This step is totally linked to what you can find in the 'c2-x.- Others: Economic cost' chapter. Within the mentioned chapter you will find all the information related to Economy.

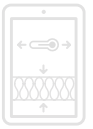

D. OUTPUTS

You will have to different outputs for your calculation results, on screen or in a printable form. You will have access to them by clicking on 'Results'.

D1. ON SCREEN

The screenshot shows the TechCalc software interface with the following components:

- 1 Output selector:** A panel on the left titled 'SELECTION' with a dropdown menu for 'Pipe Component Nr.2'. It includes checkboxes for 'V.0 (Uninsulated)', 'V.1 (Version 1)', and 'Saving', along with 'Compare versions' options.
- 2 Output main results:** A table titled 'Summary of results' comparing three scenarios: Uninsulated, Version 1 (Thermal Bridge), and Saving. The table includes rows for Heatloss, Heatloss (Area insulated), Total heatloss, and T-surface.
- 3 Output secondary data:** A tree view on the right side of the main results panel, listing components like Insulation System, Medium, Climate, Thermal Bridge, Economy, and Disclaimer.
- 4 Graphical output:** A 3D model of a pipe with a thermal bridge, located in the bottom left panel.

- 1 Output selector:** you can choose different outputs and comparisons between solutions
- 2 Output main results:** a summary of the different thermal related calculations. It will change depending on the calculation method chosen (see c2.- Calculation methods)
- 3 Output secondary data:** all the data used for the calculation setting is available in this section
- 4 Graphical output:** picture with solution selected and all the data link to it



OUTPUT SELECTOR

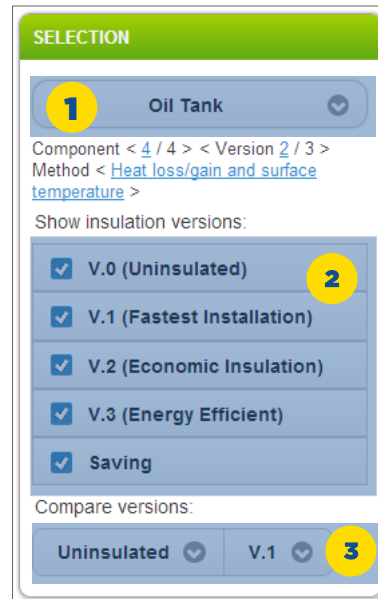

1 Component selector: you can choose between the different created components by clicking on this area. Outputs shown on screen will correspond to the selected component.

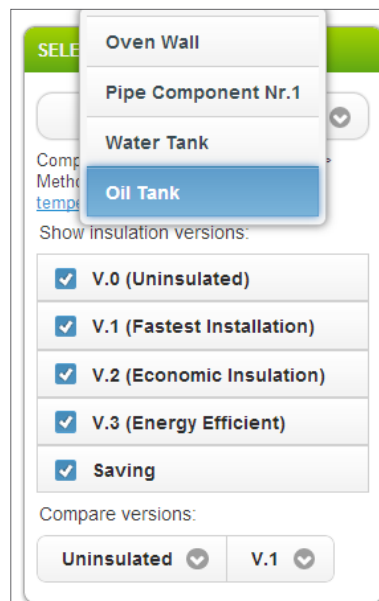

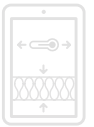

- 2 Output selector:** you can choose different outputs and comparisons between solutions

Show insulation versions:

	Uninsulated	Version 1	Version 2	Version 3	Saving
<input checked="" type="checkbox"/> V.0 (Uninsulated)					
<input checked="" type="checkbox"/> V.1 (Fastest Installation)					
<input checked="" type="checkbox"/> V.2 (Economic Insulation)					
<input checked="" type="checkbox"/> V.3 (Energy Efficient)					
<input checked="" type="checkbox"/> Saving					
Heatloss	4,479.79 W/m ²	138.13 W/m ²	136.01 W/m ²	115.98 W/m ²	4,341.65 W/m ²
Heatloss (Area insulated)	4,479.82 W/m ²	123.66 W/m ²	123.41 W/m ²	105.23 W/m ²	4,356.15 W/m ²
Total heatloss	197,031.32 W	6,075.45 W	5,981.93 W	5,100.96 W	190,955.88 W
T-surface	209.78 °C	19.47 °C	19.33 °C	17.96 °C	

Show insulation versions:

	Version 1	Version 2	Version 3
<input type="checkbox"/> V.0 (Uninsulated)			
<input checked="" type="checkbox"/> V.1 (Fastest Installation)			
<input checked="" type="checkbox"/> V.2 (Economic Insulation)			
<input checked="" type="checkbox"/> V.3 (Energy Efficient)			
<input type="checkbox"/> Saving			
Heatloss	138.13 W/m ²	136.01 W/m ²	115.98 W/m ²
Heatloss (Area insulated)	123.66 W/m ²	123.41 W/m ²	105.23 W/m ²
Total heatloss	6,075.45 W	5,981.93 W	5,100.96 W
T-surface	19.47 °C	19.33 °C	17.96 °C

- 3 Compare insulation versions:** the 'Saving' column is reserved for comparing results between two different solutions.

Compare versions:

Uninsulated V.1

By clicking on any of the two selectors, you can modify the comparison calculation.

Compare versions:

	Uninsulated	Version 1	Version 2	Version 3	Saving
Heatloss	4,479.79 W/m ²	138.13 W/m ²	136.01 W/m ²	115.98 W/m ²	4,341.65 W/m ²
Heatloss (Area insulated)	4,479.82 W/m ²	123.66 W/m ²	123.41 W/m ²	105.23 W/m ²	4,356.15 W/m ²
Total heatloss	197,031.32 W	6,075.45 W	5,981.93 W	5,100.96 W	190,955.88 W
T-surface	209.78 °C	19.47 °C	19.33 °C	17.96 °C	

Compare versions:

	Uninsulated	Version 1	Version 2	Version 3	Saving
Heatloss	4,479.79 W/m ²	138.13 W/m ²	136.01 W/m ²	115.98 W/m ²	20.03 W/m ²
Heatloss (Area insulated)	4,479.82 W/m ²	123.66 W/m ²	123.41 W/m ²	105.23 W/m ²	18.17 W/m ²
Total heatloss	197,031.32 W	6,075.45 W	5,981.93 W	5,100.96 W	880.97 W
T-surface	209.78 °C	19.47 °C	19.33 °C	17.96 °C	



OUTPUT MAIN RESULTS

	Uninsulated	Version 1	Version 2	Version 3	Saving
Heatloss	4,479.79 W/m ²	138.13 W/m ²	136.01 W/m ²	115.98 W/m ²	20.03 W/m ²
Heatloss (Area insulated)	4,479.82 W/m ²	123.66 W/m ²	123.41 W/m ²	105.23 W/m ²	18.17 W/m ²
Total heatloss	197,031.32 W	6,075.45 W	5,981.93 W	5,100.96 W	880.97 W
T-surface	209.78 °C	19.47 °C	19.33 °C	17.96 °C	

OUTPUT SECONDARY DATA

You can click on any of the secondary data labels to get the information related to the tag:

Insulation System

Insulation outside

1 : TECH Wired Mat MT 5.1

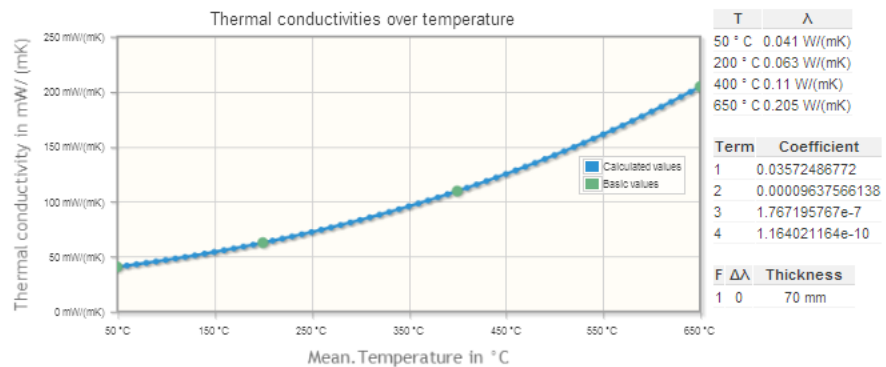

Medium

Medium Type: fluid

Temperature inside: 210 °C

hi-Value: ∞ W/(m²K)

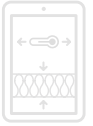

Climate

Ambient temperature: 10 °C

Wind: 4 m/s

he-Value:

Version 0: 22.40 W/(m²K)

Version 1: 14.58 W/(m²K)

Version 2: 14.58 W/(m²K)

Version 3: 14.56 W/(m²K)

Economy

Currency: EUR

Energy Cost: 0 EUR/kWh

Energy Efficiency of the heating system: 1

Disclaimer

Calculation results are based exclusively on entered values and boundary conditions. These calculations are only an estimation of the actual temperatures, and heat losses because it is impossible to accurately define real life conditions such as radiation, wind speed, relative humidity...

GRAPHICAL OUTPUT

If you click on the  icon, you will have a more detail graphical output:

Oil Tank



T-inside: 210 °C	T-ambient: 10 °C
Height: 6 m	Diameter: 2 m
Area uninsulated: 43.982 m ²	
Area insulated: 48.473 m ²	
he-Value: 14.61 W/(m ² K)	
hi-Value: ∞ W/(m ² K)	
Orientation: Vertical outdoor	

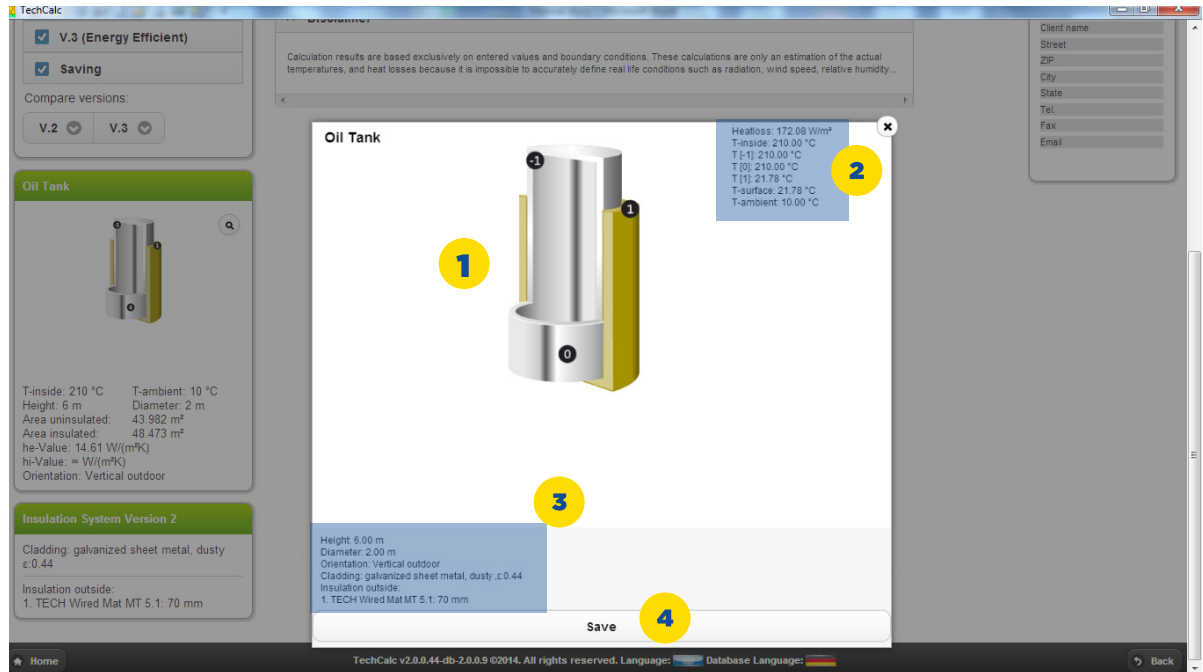

- 1 **Solution graph:** component view with the layers used for insulation
- 2 **Temperatures between layers:** different temperatures profile for the different points in your system, from the wall to the cladding
- 3 **Case data:** summary of scenario data
- 4 **Save button:** clicking on 'Save' you can save an image of this detailed view as .PNG file. A dialog box will appear to let you save the file wherever you want in PC

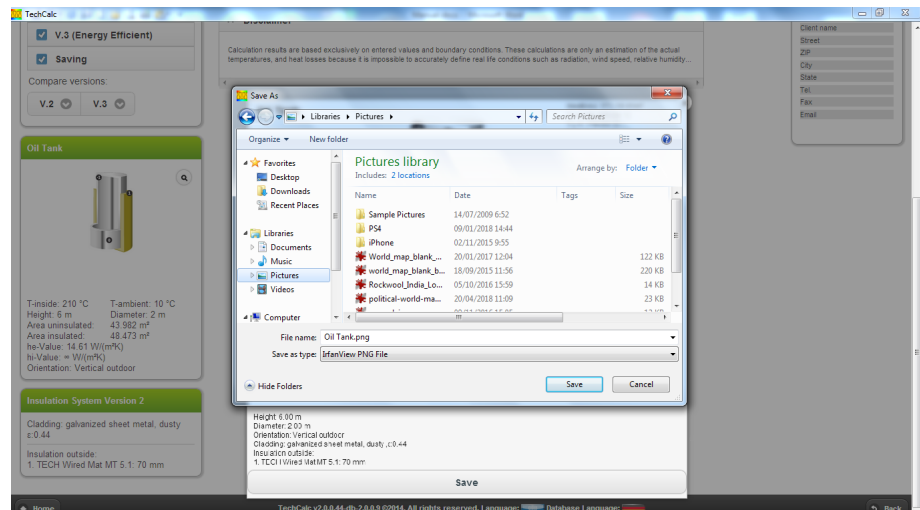

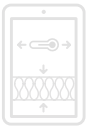

D1. PRINT OUT

You can select between two kinds of files, .PDF (Component or Full report) or .RTF (full report).

Component report

Full report

Text report

COMPONENT REPORT

In this report you will find information related just to the component chosen on the screen (see 'Component selector').

The report is split in three main parts:

- » **Boundary Conditions and Summary of results:** the first page of the report is used to show which are the boundary conditions taken into account for the calculations (all the inputs made through steps 1-5) together with the calculation method chosen and the summary of the results obtained depending on the calculation method chosen.
- » **Insulation System Version:** second page is dedicated to the more relevant information linked to the different insulation system created. Information about thermal bridges defined is also shown, including F factor and $\Delta\lambda$ values and choices.
- » **Insulation Products Specification:** third page is dedicated to describe the thermal properties of the insulation products used in the different defined insulation systems.

Version	Name	Compare versions
V. 0	Uninsulated	Economic insulation : Fast installation
V. 1	Fast installation	
V. 2	Economic insulation	
V. 3	Energy Efficient	

Summary	V. 0	V. 1	V. 2	V. 3	Saving
Heatloss	4480	151	97	127	-15 W/m ²
Heatloss (Area insulated)	4480	136	151	115	-16 W/m ²
Total heatloss	197031	6663	7336	5594	-673 W
T-surface	209.78	20.38	21.42	18.73	°C
be-Value	22.4	14.59	14.61	14.57	W/(m ² K)

Layer Name	Thickness mm	Lambda(m ²) mW(m ² K) °C	Boundary T °C	Fm	Fa	Fc	Fo	Fd	Fj	F	delta-Lambda W(m ² K)
1 TECH Crespeo Rail 2.0	80	63.92	210	1	1	1	1	1	1.1	1.1	0

Layer Name	Thickness mm	Lambda(m ²) mW(m ² K) °C	Boundary T °C	Fm	Fa	Fc	Fo	Fd	Fj	F	delta-Lambda W(m ² K)
1 TECH Wind Mat MT 5.1	70	61.91	210	1	1	0.96	1	1	1.1	1.078	0.01

Layer Name	Thickness mm	Lambda(m ²) mW(m ² K) °C	Boundary T °C	Fm	Fa	Fc	Fo	Fd	Fj	F	delta-Lambda W(m ² K)
1 U TECH Wind Mat MT 6.0	70	46.95	210	1	1	1	1	1	1.1	1.1	0

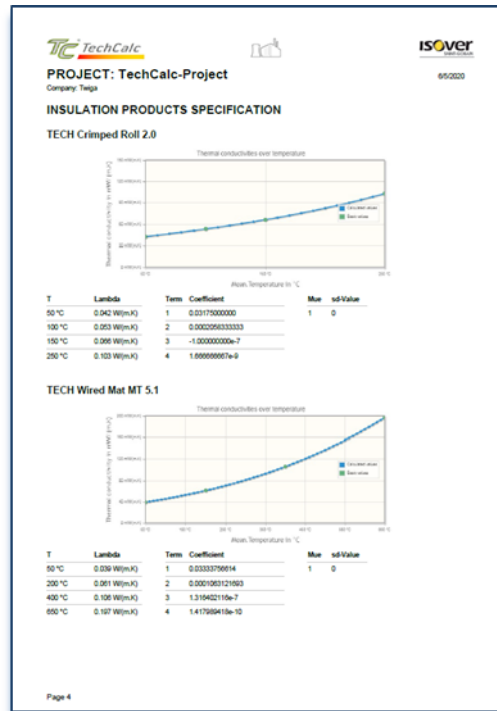

FULL REPORT

In this report you will find information related to the whole project, including results for all the components together. The structure is identical to the 'Component report', with detailed results for each component, but with the addition of the whole project summary:

PROJECT SUMMARY

Component	Version	Active	Total heatloss
Pipe Component Nr.1	Version 1	Yes	24205.65 W
Water Tank	Version 1	Yes	3348.12 W
Sum (only active versions)			27553.77 W

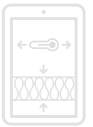

TEXT REPORT

This option is available in order to send text messages with the results of a calculation. TechCalc will generate a flat text file (.RTF) where you will find the highlights of your selected component calculations and boundary conditions:

```

### Uninsulated
Version 1
(Thermal Bridge)
Saving
Heatloss
  Uninsulated 8,265.30 W/m
  Version 1 (Thermal Bridge) 161.37 W/m
  Saving 8,103.92 W/m
Heatloss (Area insulated)
  Uninsulated 9,637.11 W/m²
  Version 1 (Thermal Bridge) 118.63 W/m²
  Saving 9,518.48 W/m²
Total heatloss
  Uninsulated 1,239,794.36 W
  Version 1 (Thermal Bridge) 24,205.65 W
  Saving 1,215,588.71 W
T-surface
  Uninsulated 249.52 °C
  Version 1 (Thermal Bridge) 14.51 °C
  Saving Minimum insulation thickness (Total)
  Uninsulated
  Version 1 (Thermal Bridge) 80 mm
  Saving Dewpoint temperature outside
  Uninsulated 0.00 °C
  Version 1 (Thermal Bridge) 0.00 °C
  Saving Dewpoint temperature inside
  Uninsulated 0.00 °C
  Version 1 (Thermal Bridge) 0.00 °C
  Saving axial temp. decrease
  Uninsulated 0.00 °C
  Version 1 (Thermal Bridge) 0.00 °C
  Saving Energy Consumption (0 h/a)
  Uninsulated 0.00 kWh/a
  Version 1 (Thermal Bridge) 0.00 kWh/a

```

No matter which kind of print out output your select, TechCalc will always demand for a file name and a folder to be saved. Once you have done this, the file will be available at the folder you chose.



E. OTHER FUNCTIONS

Aside from all the calculations functions, there are other important features inside TechCalc that will allow you to customize your needs.

You can access to this special features through the icons based at the right upper part of your screen:

	Uninsulated	Version 1	Saving
Heatloss	8,265.30 W/m	161.37 W/m	8,103.92 W/m
Heatloss (Area insulated)	9,637.11 W/m²	118.63 W/m²	9,518.48 W/m²
Total heatloss	1,239,794.36 W	24,205.65 W	1,215,588.71 W
T-surface	249.52 °C	14.51 °C	

E1. NEW PROJECT

To create a new project, starting from scratch, you can click on  symbol. A dialog box will appear asking if you really want to start a new project (be careful because all information of the current project will be lost if it's not been saved previously (see e.2 for saving files))

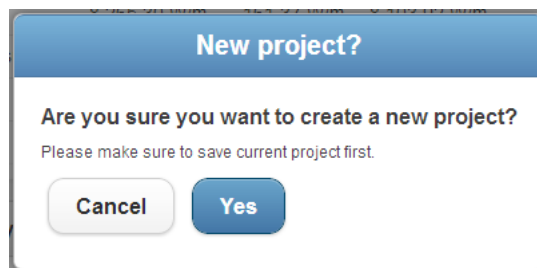

Automatically you will be placed in the Step 1: Components, with everything cleaned up.

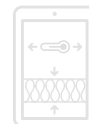

E2. SAVE FILE

To save a file with all the information of your current project included, you need to click on  symbol. A classic Windows dialog box will appear to select the folder where you want to save the file and the file name. The file extension for TechCalc files will be always .JSON:

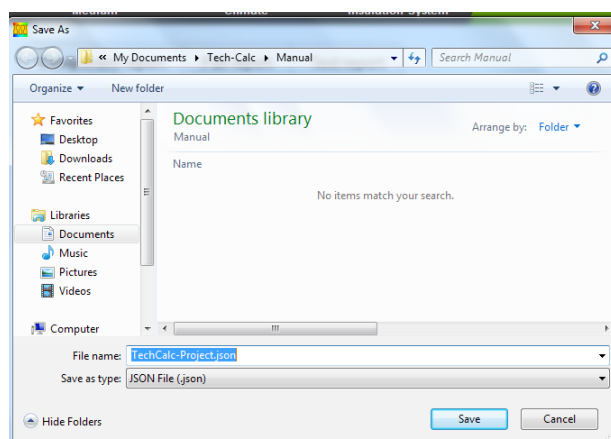

E3. DATABASE ACCESS AND MANAGE

TechCalc database is an opened database, what means that you can create or delete your own Catalogs and Products. Catalogs and products set by default (ISOVER) are protected and you won't be able neither to edit them, nor to delete them.

Not only products can be managed but Materials, Mediums, Claddings, Climates and Thermal Bridges can be managed as well.

To access the database, just click on the  symbol. Once you have clicked on this icon you will arrive to the database screen.

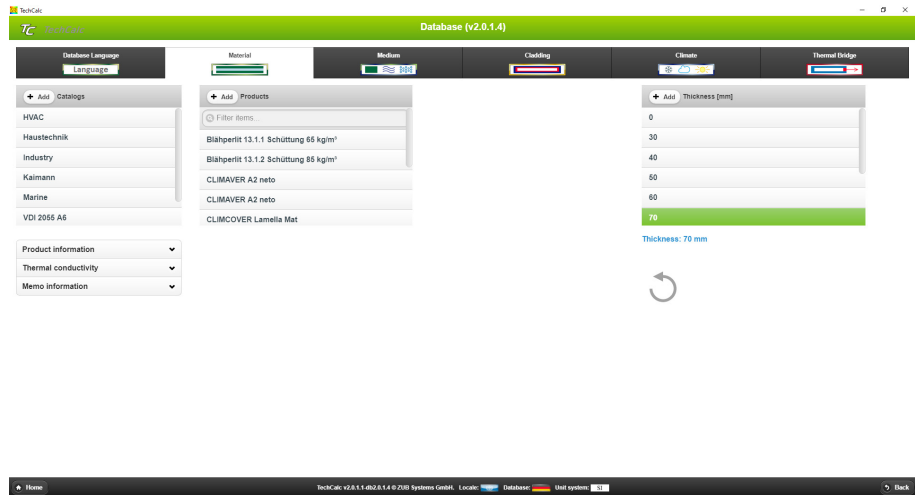

MATERIAL

Materials are split in three concepts: Catalogs, Products and Thickness (mm).

A 'Catalog' is a compound of several products grouped by a concept. You can create as many Catalogs as you may need. To create a new Catalog, click on **+ Add Catalogs**. A new Catalog will appear and you will have to name it:

New catalog

Name:

Cancel
Add

Once the Catalog is named, click on 'Add'. The new Catalog will be part of the Catalogs list:



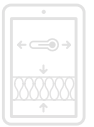

This new Catalog is now empty, but you can create as many Products as you want inside this new created Catalog.

To create a product, you can repeat the steps for creating a Catalog but clicking on **+ Add Products**. A new dialog box will appear with the different parameters that characterized a product from the insulation point of view:

New Material

Name:

max. temperature inside [°C] <input type="text" value="0"/>	max. temperature outside [°C] <input type="text" value="0"/>
mue-value(-1 = no value) <input type="text" value="0"/>	sd-value lamination (0=no lamination) [m] <input type="text" value="0"/>
min. temperature inside[°C] <input type="text" value="0"/>	Function <input style="border: 1px solid gray; border-radius: 5px; padding: 2px 10px;" type="button" value="constant"/>

Mean temp. 1 [°C] <input type="text" value="0"/>	Mean temp. 2 [°C] <input type="text" value="0"/>	Mean temp. 3 [°C] <input type="text" value="0"/>	Mean temp. 4 °C <input type="text" value="0"/>
Conductivity. 1 [W/(m.K)] <input type="text" value="0"/>	Conductivity. 2 [W/(m.K)] <input type="text" value="0"/>	Conductivity. 3 [W/(m.K)] <input type="text" value="0"/>	Conductivity. 4 [W/(m.K)] <input type="text" value="0"/>

Coefficient. 1 <input type="text" value="0"/>	Coefficient. 2 <input type="text" value="0"/>	Coefficient. 3 <input type="text" value="0"/>	Coefficient. 4 <input type="text" value="0"/>
--	--	--	--

Memo. 1

Memo. 2

Memo. 3

Memo. 4

Memo. 5

Memo. 6



The fields you have in this screen are:

Name: Name you want to give to this new Product. (Mandatory field)

Max temperature inside (°C): This is what is usually called MST (Maximum Service Temperature) and it is the maximum temperature to what the insulation can be exposed in contact with the hottest part of your system. (Mandatory field)

Max temperature outside (°C): This is the maximum temperature your product can endure in the outer face. This is a limitation for those products using a facing that could be damaged, unglued, etc. in case of exceeding this temperature. In case of no facing, this temperature will be the same than the 'Max temperature inside °C'. (Mandatory field)

Mue-value: This is the water vapor resistance factor of your product. This value is only used in case of using the calculation method for 'Moisture accumulation on a cooling component'. The most common values for insulation materials given in ISO 10456 are:

Material	Water vapour resistance factor μ	
	dry	wet
Expanded polystyrene	60	60
Extruded polystyrene foam	150	150
Polyurethane foam, rigid	60	60
Mineral wool	1	1
Phenolic foam	50	50
Cellular glass	∞	∞
Perlite board	5	5
Expanded cork	10	5
Wood wool board	5	3
Wood fibreboard	5	3
Urea-formaldehyde foam	2	2
Spray applied polyurethane foam	60	60
Loose-fill mineral wool	1	1

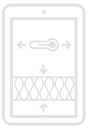

Sd-value: This is the equivalent air layer thickness of your material/facing. As the 'Mue-value', it is just used in case of using the calculation method for 'Moisture accumulation on a cooling component'. Some examples of these values are also given in ISO 10456:

Product/material	Water vapour diffusion-equivalent air layer thickness s_d m
Polyethylene 0,15 mm	50
Polyethylene 0,25 mm	100
Polyester film 0,2 mm	50
PVC foil	30
Aluminium foil 0,05 mm	1 500
PE-foil (stapled) 0,15 mm	8
Bituminous paper 0,1 mm	2
Aluminium paper 0,4 mm	10
Breather membrane	0,2
Paint - emulsion	0,1
Paint - gloss	3
Vinyl wallpaper	2

NOTE 1 The water vapour diffusion-equivalent air layer thickness of a product is the thickness of a motionless air layer with the same water vapour resistance as the product. It is an expression of resistance to diffusion of water vapour.

NOTE 2 The thickness of the products in Table 5 is not normally measured and they can be regarded as very thin products with a water vapour resistance. The table quotes nominal thickness values as an aid to the identification of the product.

Min temperature inside (°C): This is an optional value to set a limit in the minimum temperature that your product can be exposed to.

Function: To create the Temperature vs Lambda values curve, TechCalc allows you to select the mathematical interpolation method you want to use. You can select among this three methods:

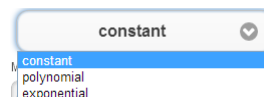

We recommend to always use the 'polynomial' approach because it is the most common approach to create a grade 3 polynomic function and it is the way how it is done in different recognized standards, as VDI 2055 or AGI Q 132.

Mean Temp (°C): There are 4 fields for mean temp in °C. Each of them will part of the 'pair' Temperature - Lambda value (Conductivity). (Mandatory fields)

Conductivity (W/mK): There are 4 fields for conductivity in W/mK. Each of them will part of the 'pair' Temperature - Lambda value (Conductivity). Be aware about



Coefficient: In some specific cases instead of providing the 'pairs' Temperature - Lambda value, you can provide directly the polynomial coefficients. This would be the coefficients corresponding to the polynomial function:

$$\lambda(\theta) = a_0 + a_1 \cdot \theta + a_2 \cdot \theta^2 + a_3 \cdot \theta^3$$

In case you introduce 'pairs' Temperature - Lambda values, once you have filled in the values, you must click on 'Calculate coefficient' button:

Calculate Coefficient

Memo: In any of the 6 memo fields available you can write whatever information you consider important or interesting linked to your product (DoP code, Commercial information, etc.)

Once you have filled in, at least the mandatory fields, you can click on 'Add' and the product will be added to the product list inside your Catalog:

+ Add Catalogs	+ Add Products
ISOVER Italia	Filter items...
International (VDI 2055 A6)	new material ✕
Structural Material	
TechCalc catalog for Manual ✕	



+ Add Catalogs	+ Add Products
ISOVER Italia	Filter items...
International (VDI 2055 A6)	
Structural Material	
TechCalc catalog for Manual ✕	

For deleting, either a Catalog or a Product, you just have to click on the ✕ symbol on the right. A dialog box will now appear to confirm you really want to delete it:

Delete entry?

Are you sure you want to delete this entry?

This action cannot be undone.

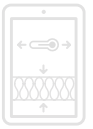

MEDIUM

Steps for creating or deleting a Medium are exactly the same than for Products. What is now different are the technical parameters that define the Medium:

Medium information ^

Fluid **Gaseous**

Density [kg/m³]
1.17

Heat capacity [kJ/kgK]
2.177

Conductivity [W/(mK)]
0.053

Pressure [Pa]
101300

Temperature [° C]
300

CLADDING

Steps for creating or deleting a Cladding are exactly the same than for Products. What is now different are the technical parameters that define the Cladding:

Cladding information ^

Emissivity
0.05

Radiation coefficient CH
2.5

Radiation coefficient CV
2.7

All fields are mandatory.



CLIMATE

Steps for creating or deleting a Climate condition are exactly the same than for Products. What is now different are the technical parameters that define the Climate condition:

Climate information
▲

Ambient temperature [° C]

Relative humidity outside [%]

Wind [m/s]

THERMAL BRIDGE

Steps for creating or deleting a Thermal Bridge are exactly the same than for Products. What is now different are the technical parameters that define the Thermal Bridge:

Thermal Bridge information
▲

Single supplementary value [W/(mK)]

UB AB Factor [W/K]

Choice

regular insulated-related thermal bridge or insert

Plant related or irregularly spaced insulation-related thermal bridge

Information

In this case the only mandatory field is the 'Single supplementary value [W/(mK)]' that is the value that will be used for the calculations.

Values for 'UB AB Factor [W/K]' or the multiple choice field 'Choice' will be ready in future versions. These values are linked with the German standard VDI 4610. Information value can be filled in but is just an information field with no influence in the calculations.

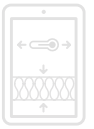

Any new item you create (Material, Medium, Cladding or Thermal Bridge) will be saved only in the Database Language you are working with. You have always the current active Database Language in the bottom part of your screen:



TechCalc v2.0.1.1-db2.0.1.4 © ZUB Systems GmbH. Locale:  Database:  Unit system: 

To change the Database Language, just click on the Database Language flag and you will arrive to the Database Language screen:

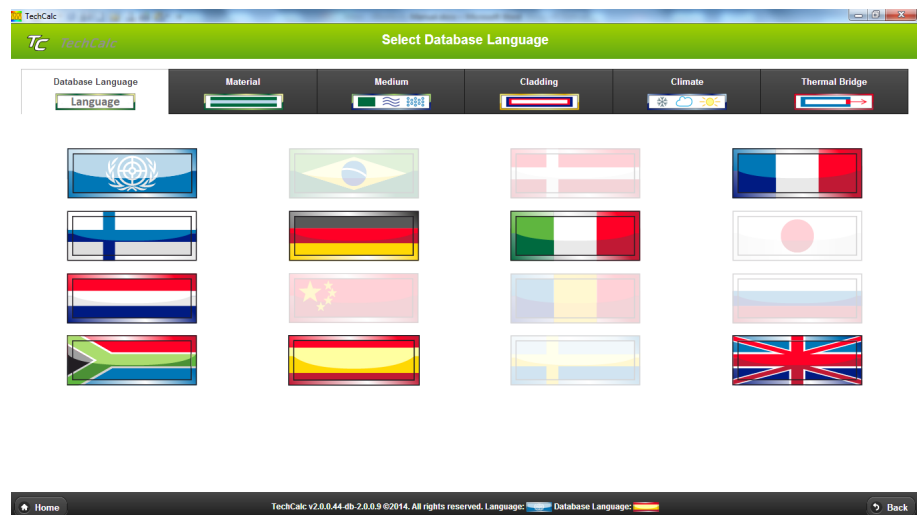

Select here the Database Language and immediately you'll change the working database. From now on you will be working with this database until you change it again.

The new selected Database Language will appear now in the bottom ribbon.



E4. PERSONALIZE YOUR REPORT

With this feature you can set the information linked to your project (Project and Client information). For customizing your report click on  symbol. Next screen will be shown:

The screenshot shows the 'Settings' screen in the TechCalc application. The 'Project Information' section is expanded, revealing the following fields:

- Object:
- Project number:
- Project name:
- Comment:

Below these fields are three collapsed sections: 'Client information', 'License information', and 'Release information'. At the bottom of the form are 'Back' and 'Save' buttons. The footer of the application window displays 'TechCalc v2.0.0.44-4b-2.0.0.9 ©2014. All rights reserved. Language: [English] Database Language: [Spanish]'.

No fields are mandatory in this section. You can fill in whatever fields related to the information you want to appear later on in your report. As an example, we show you here how the final report will look like depending on what you have filled in.

This screenshot shows the 'Project information' section of a report, reflecting the data entered in the settings screen:

- Object: Tanks and pipe line
- Project number: 1534
- Project name: TechCalc Example Project
- Comment: All calculations are for this manual

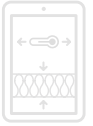

Client information		
Company Saint-Gobain ISOVER	First name Mr. XXXX	Last name YYYYY
Street No Name Street, 132	ZIP 60488	City Frankfurt am Main
State Hessen		
Tel. +49 155 67 89 97	Fax	Email XXXX@ZZZ.com
Logo isover.png	Change Logo (png, jpg) Choose File isover.png	

Just as a remark, you can choose any image file you want to place a logo in your report.

Once you have filled in the different fields, click on 'Save' button and then press 'Back'.

With these entries, this is what you will find in header of your PDF report:



PROJECT: TechCalc Example Project

Company: Saint-Gobain ISOVER Client name: Mr. XXXX YYYYY
Address: No Name Street, 132 - Frankfurt am Main - 60488 - Hessen
Tel.: +49 155 67 89 97, Email: XXXX@ZZZ.com

5/14/2018



Note that the chosen logo will appear in the shadowed area of the image above.

Some additional information (License and Release) is available in this section, but you cannot edit it:

License information	
Activation key	Expiry date
	2045-08-18
Release information	
Installed software version	Installed database version
2.0.1.1	2.0.1.4
Latest software version	Latest database version
2.0.1.0	2.0.1.4
Download latest version	Update Database

You have here the option of checking if you have installed last versions of software and database and in case you need it, proceed to an updating process automatically.





E5. CHANGE LANGUAGE OR DATABASE

For changing the software language see b3.- Language selection.

For changing database see e3.- Database access and manage.

You can always change either the software language or database through the bottom ribbon in your screen by just clicking either in the Language flag or the Database Language flag:



TechCalc v2.0.0.44-db-2.0.0.9 ©2014. All rights reserved. Language:  Database Language: 

E6. CHANGE UNITS

You can choose the units you want to use between two choices: SI (International System units) or IP (Imperial System units)



TechCalc v2.0.1.1-db2.0.1.4 © ZUB Systems GmbH. Locale:  Database:  Unit system: 

By just clicking in the area pointed out with the arrow, a pop up message will appear:

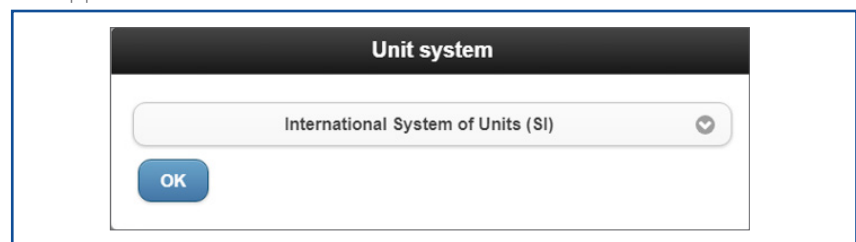

Select the system you want to use and units will be change in all the different steps of the software. See how it looks like regarding results when you select 'Imperial System' units:

Summary of results			
	Uninsulated	Version 1 (Thermal Bridge)	Saving
Heatloss	1,143.26 BTU/(ft² h)	36.04 BTU/(ft² h)	1,107.21 BTU/(ft² h)
Heatloss (Area insulated)	1,143.26 BTU/(ft² h)	36.04 BTU/(ft² h)	3,570.46 BTU/(ft² h)
Total heatloss	12,305.91 BTU/h	387.98 BTU/h	11,917.93 BTU/h
T-surface	481.68 °F	162.28 °F	

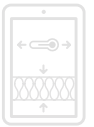

Examples of different steps using IP units:

TechCalc-Project

1 Components 2 Calculation Methods 3 Medium 4 Climate 5 Insulation System Thermal Bridges Economy Results

Name: Wall Component Nr.1_VDI

Length (ft): 3.28

Height (ft): 3.28

Area uninsulated (ft²): 10.784

Area insulated (ft²): 10.784

Standard: ISO VDI ASTM

Heatloss: Δq ∇q

Characteristic length (ft): 0.82

Select an orientation: Horizontal indoor

Wall Component Nr.1_VDI
 Heat loss/gain and surface temperature:
 Length: 3.28 ft
 Height: 3.28 ft
 Orientation: Horizontal indoor
 T-inside: 482.00 °F T-ambient: 68.00 °F
 Insulation System Version: 1
 TECH-Insul-Mat-MT-S-1

Please define a component. [Add](#)

TechCalc-Project

1 Components 2 Calculation Methods 3 Medium 4 Climate 5 Insulation System Thermal Bridges Economy Results

Name:

Ambient temperature: 50 °F

Wind: 13.12336 ft/s

Database:

Cylinder Component Nr.7
 Heat loss/gain and surface temperature:
 Height: 13.66 ft Diameter: 6.56 ft
 Orientation: Vertical outdoor
 T-inside: 410.00 °F T-ambient: 50.00 °F
 Insulation System Version: 0
 U-TECH-Wired-Mat-MT-S-0

Please provide necessary climate information. [Add Data](#)



F. CALCULATION EXAMPLES

In this chapter you will find some real problems found in industrial/marine/HVAC sites and how they have been solved by using TechCalc.

EXAMPLE 1:

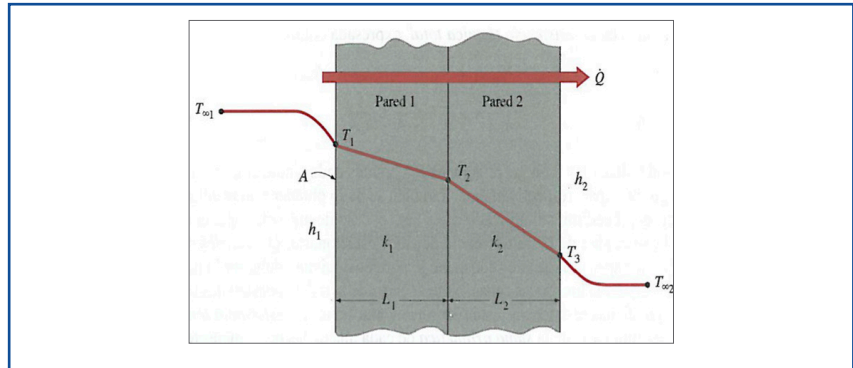

A wall 3m high, 5m wide and 0.30m thick has a thermal conductivity of $\lambda = 0.90 \text{ W/m}\cdot\text{K}$. This wall has glass wool insulation (TECH Slab 3.0) of 80 mm thickness. The temperatures of the inner media and ambient temperature that were measured were found to be $T_{\infty 1} = 180^\circ\text{C}$ (453 K) and $T_{\infty 2} = 36^\circ\text{C}$ (309 K), respectively. The cladding used is a galvanized metal sheet. Determine the heat loss through the wall on that day.

Steps to solve the problem:

i. Define the wall thermal conductivity inside TechCalc (see e.3.- Database access and manage – Materials). In this particular case we will consider that the wall has a constant conductivity of 0.90 W/mK:

New Material

Name:

max. temperature inside [° C] max. temperature outside [° C]

min. temperature inside [° C] min. temperature outside [° C]

Function: constant

Conductivity. 1 [W/(mK)] Conductivity. 2 [W/(mK)]

Coefficient. 1 Coefficient. 2 Coefficient. 3 Coefficient. 4

Memo. 1



v. Set the ambient temperature in the step 4: Climate (see c4.- Climate)

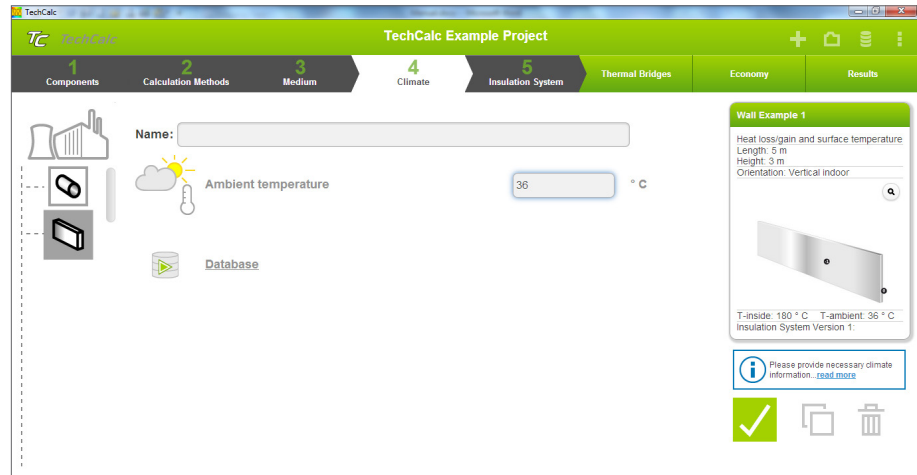

vi. Define the wall + insulation system inside TechCalc (see c5.- Insulation system):

a) Select the correct cladding:

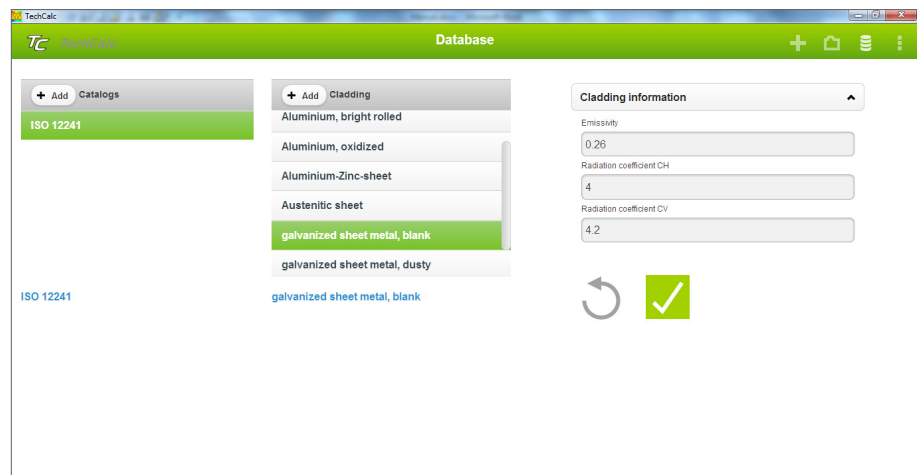

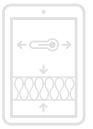

b) Select the wall defined in the step i:

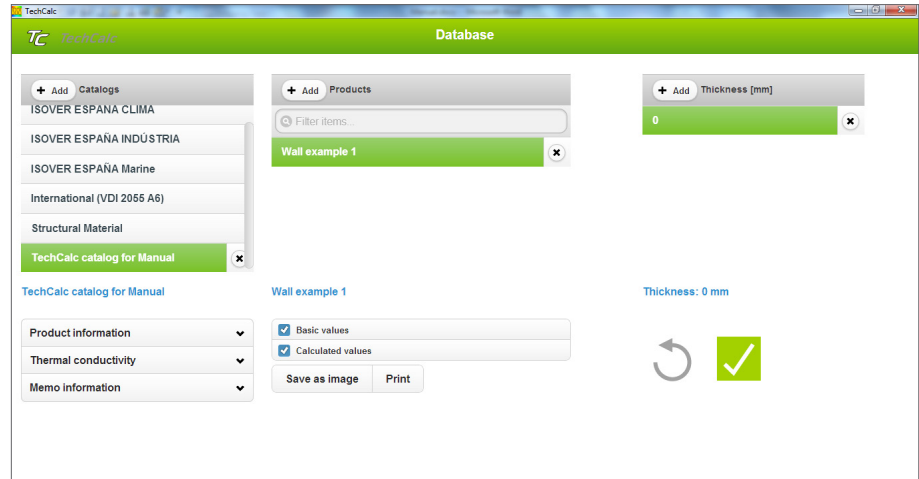

Set now the wall thickness (in mm):

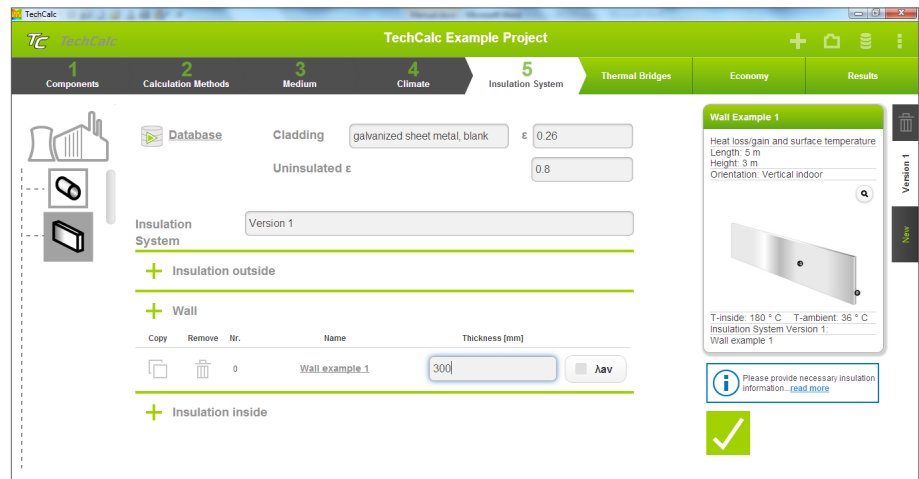

In this case, when we defined the wall thermal characteristics we didn't create a thickness list for it, but it is not a problem since thickness can be always added even if it is not a pre-set value from the list.



c) Select the insulation material and its thickness (in this case we'll take it from the Spanish Database):



Now we have completed the step 5 corresponding to the 'Insulation System':

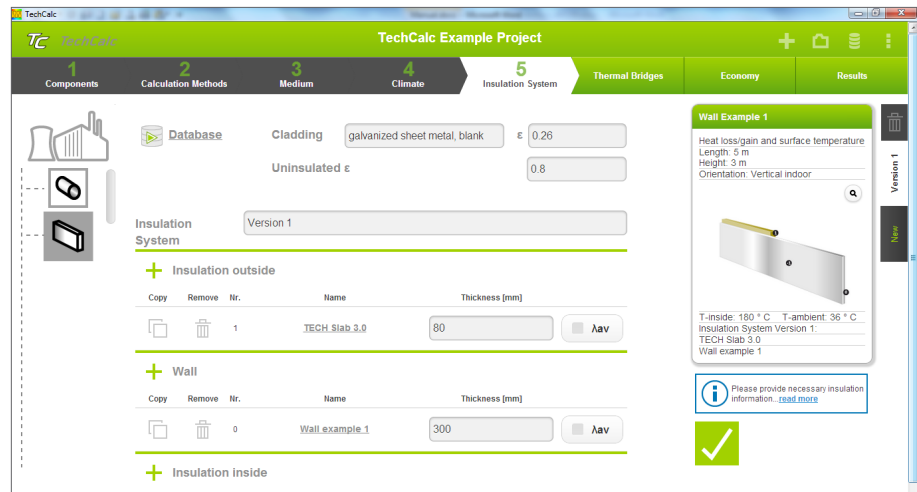

vii. Check the final results to give an answer to the problem: 'heat loss through the wall that day'

Summary of results			
	Uninsulated	Version 1	Saving
Heatloss	2,758.80 W/m ²	66.09 W/m ²	2,692.70 W/m ²
Heatloss (Area insulated)	2,758.80 W/m ²	66.09 W/m ²	2,692.70 W/m ²
Total heatloss	41,381.93 W	991.42 W	40,390.51 W
T-surface	179.86 °C	47.47 °C	

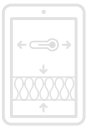

EXAMPLE 2:

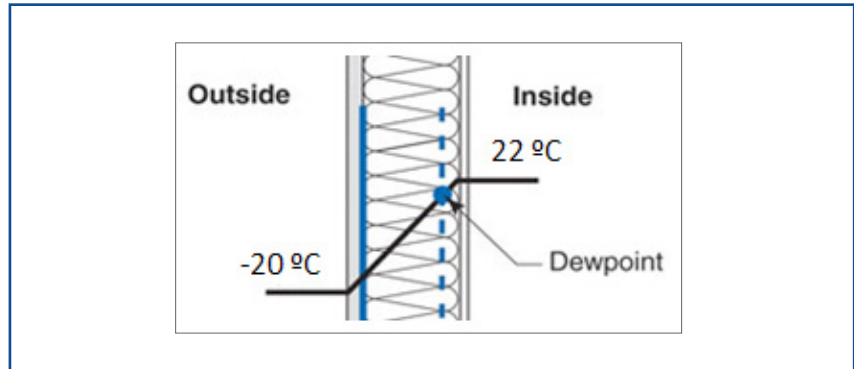

A ship is going to work in polar conditions (-20°C as ambient temperature and wind speed of 15 m/s) and the engineering company who is making the design of the ship deck wants to know what will be the minimum required thickness to avoid condensation inside (22°C and HR 50%).

Previous considerations:

TechCalc is design for calculating condensation 'outside', but 'inside' or 'outside' is just a relative point of view. To solve this problem, we will consider the 'Medium' as the outdoor conditions and 'Climate' as the indoor conditions. We can assume in this case that probable the interior is painted.

Steps to solve the problem:

i. Define the component inside TechCalc (see e.3.- Components – Walls). Since there are no dimensions mentioned in the problem statement, we will set a 1x1 m. vertical indoor (see previous considerations) wall:

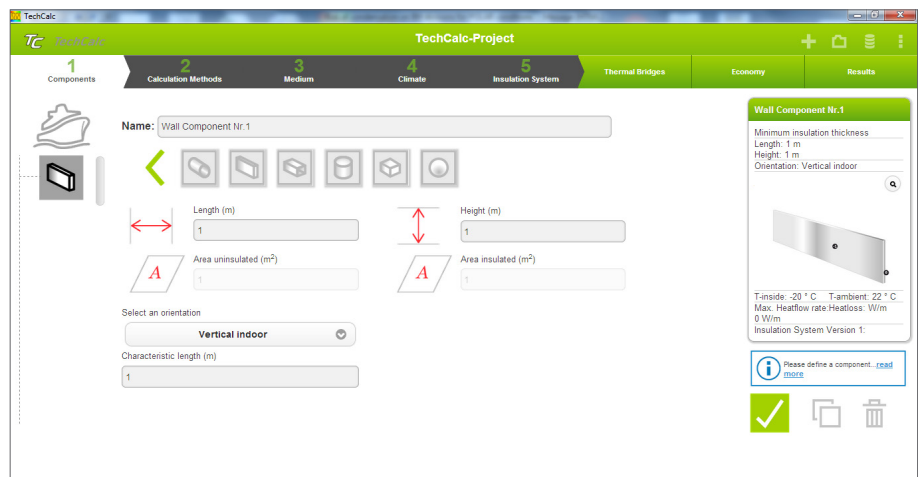



ii. Select the calculation method. In this case we need to calculate the minimum insulation thickness to avoid condensation, so we will choose 'Minimum insulation thickness - Prevention condensation' method (see c2.- Calculation methods):

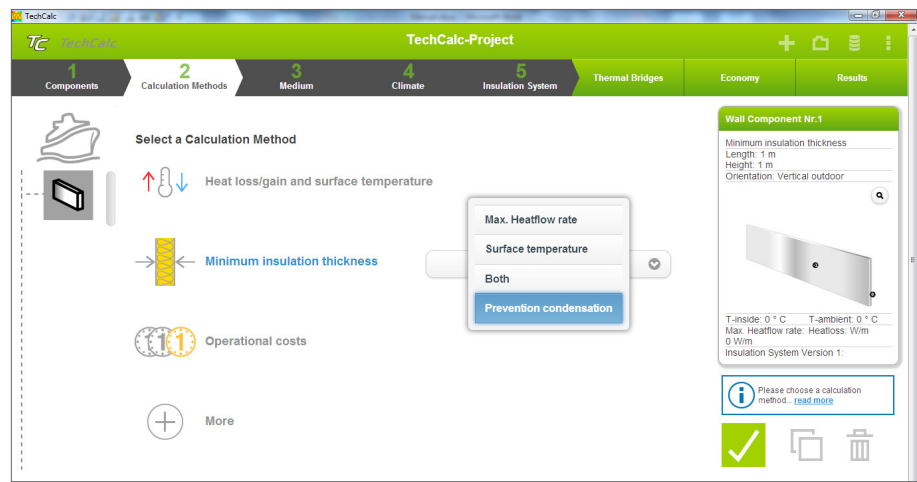

iii. Define the medium. In this case what is on stake is 'air' and not a standard fluid, so first we will select 'air' as medium (see c3.- Medium):

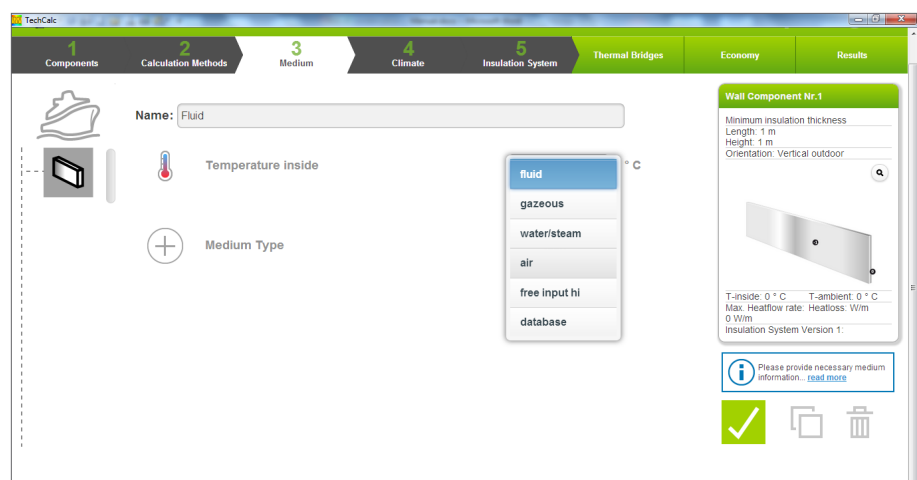

We'll set 'Temperature inside' (remember that in this case our medium is really outside so this is really the outdoor temperature) to -20°C and the velocity to 15 m/s:

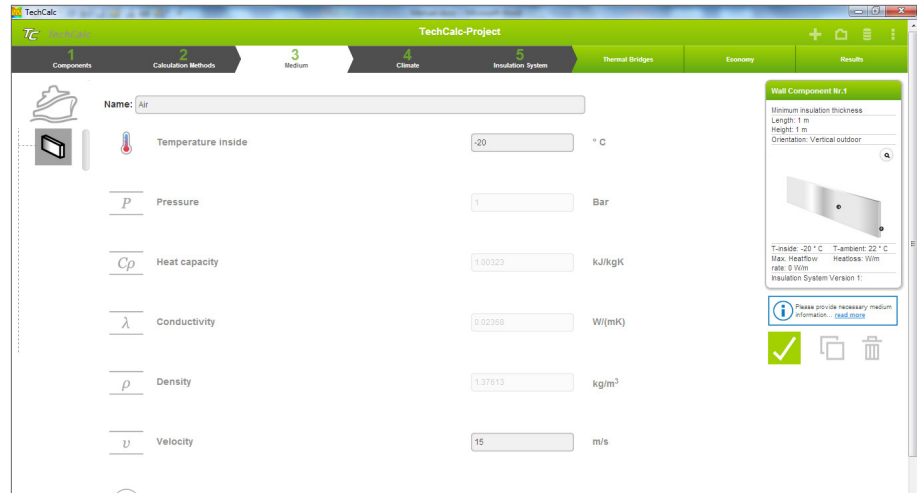
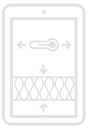

iv. Set the ambient temperature (in this case our indoor conditions) in the step 4: Climate (see c4.- Climate)

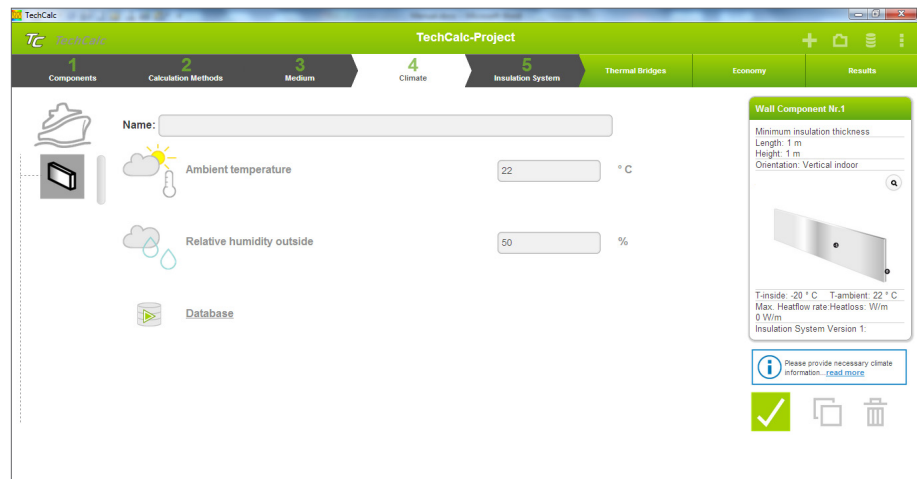

Set 22°C as 'Ambient temperature and 50% as 'Relative humidity outside'

v. In this step we have to define the wall and the insulation.

a) Select the correct cladding. In this case we have assumed that it is a painted surface, so it should be considered as a 'non-metallic surface'. Keep in mind that our cladding now is the internal part of the deck:

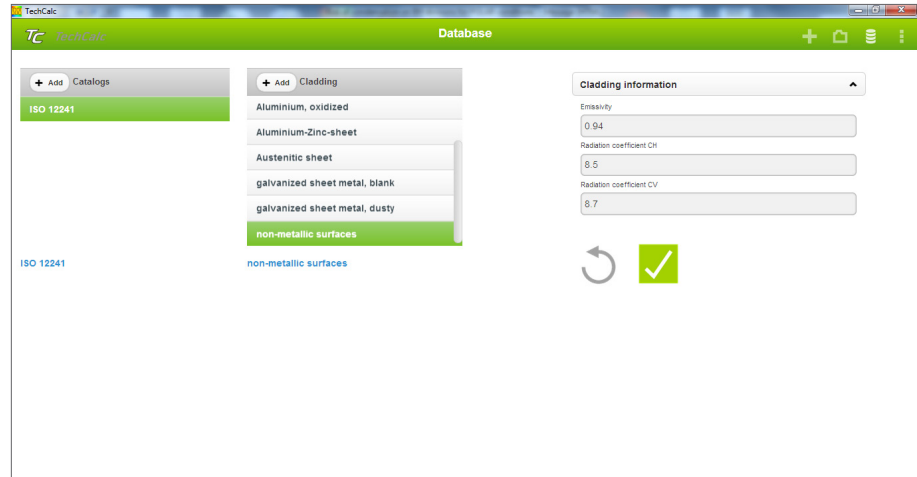

b) Select the insulation material:



vi. Check the final results to give an answer to the problem: 'minimum insulation thickness to avoid condensation inside':

Summary of results	
Version 1	
Heatloss	-94.49 W/m ²
Heatloss (Area insulated)	-94.49 W/m ²
Total heatloss	-94.49 W
T-surface	11.50 °C
Minimum insulation thickness (Total)	9 mm
Dewpoint temperature outside	11.10 °C

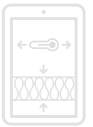

EXAMPLE 3:

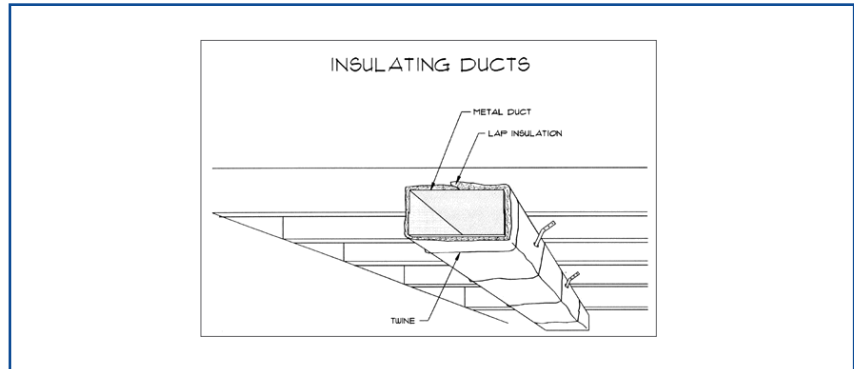

An HVAC duct is going to work in hard climatic conditions, with high ambient temperature and humidity (40°C and 60%HR). An internal humidity of 5% HR, a temperature of 5°C and an air speed of 12 m/s has been defined as the inner conditions of the cooling air in the duct. We need to know what will be the moisture accumulation inside the insulation material after 1 month. Duct dimensions are 10 m length and section of 60x40 cm. Insulation material 'CLIMCOVER Roll Alu1' in 25 mm thickness.

Steps to solve the problem:

i. Define the component inside TechCalc (see e.3.- Components – Ducts):

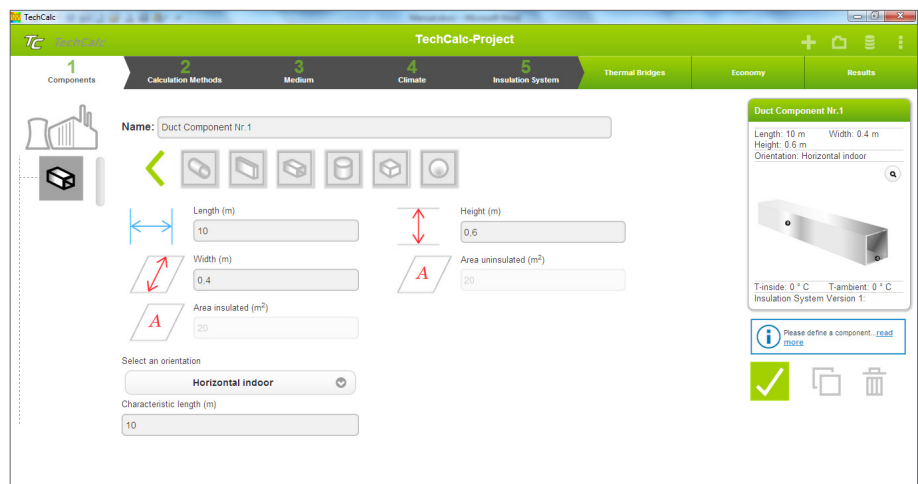



ii. Select the calculation method. In this case we need to calculate the moisture accumulation in the insulation system, so we will choose 'Moisture accumulation in a cooling component' method (see c2.- Calculation methods):

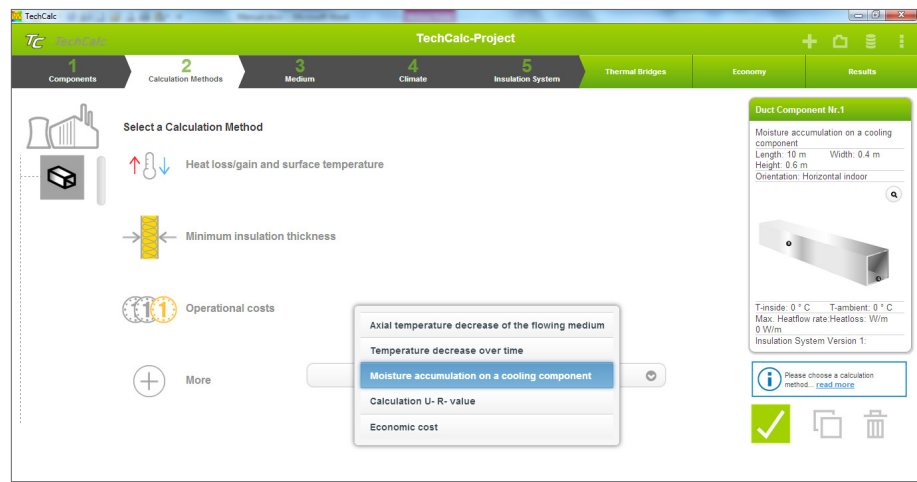

iii. Select 'air' as 'Medium type' and set the values given in the problem statement to define the 'Medium' conditions: 5°C, 5% HR and 1 month (720 h)

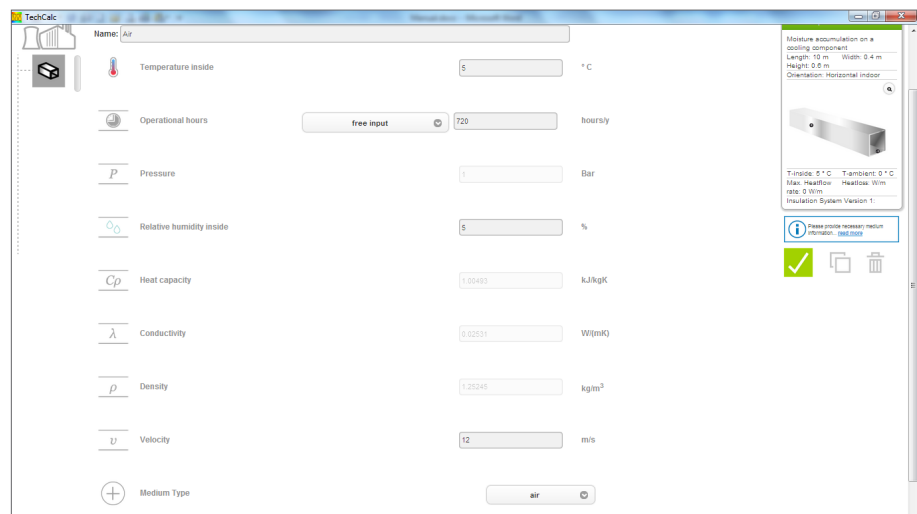

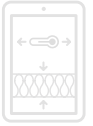

iv. Set the ambient conditions (see c4.- Climate)

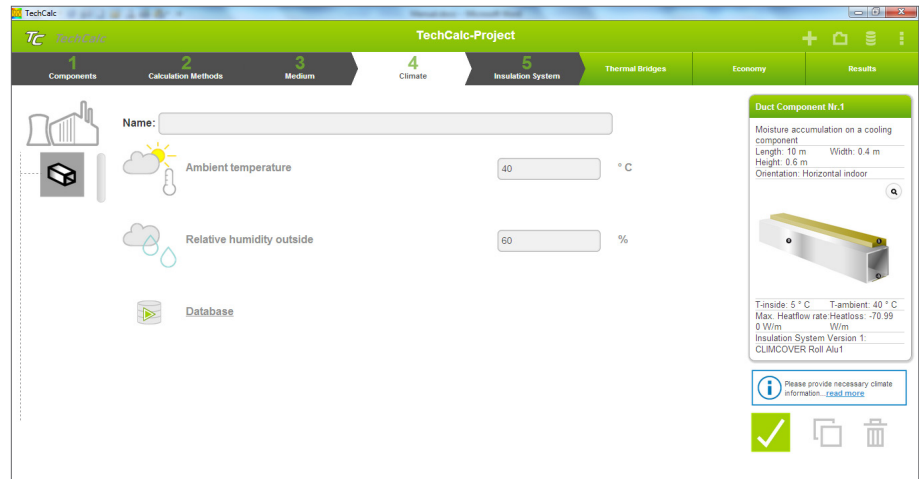

v. Define the insulation system around your duct.

a) Select the correct cladding. In this case the insulation material has an aluminium foil as external facing, so our cladding material will be:

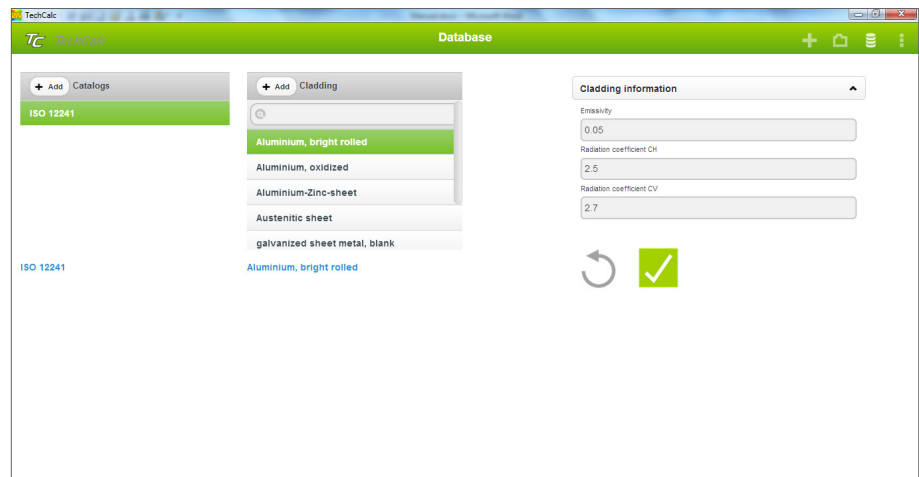



b) Select the insulation material:

The screenshot shows the TechCalc software interface. The 'Database' window is open, displaying a list of products. The 'CLIMCOVER Roll Alu1' product is selected. A graph shows the thermal conductivity of this material over a range of temperatures from 10°C to 100°C. The thickness of the insulation is set to 25 mm. The interface includes a 'Filter items' search bar and a 'Basic values' section with checkboxes for 'Basic values' and 'Calculated values'. There are also 'Save as image' and 'Print' buttons.

vii. Check the final results to give an answer to the problem: 'moisture accumulation inside of the insulation':

Summary of results	
	Version 1
Heatloss	-70.99 W/m
Heatloss (Area insulated)	-32.27 W/m ²
Total heatloss	-709.92 W
T-surface	31.65 °C
Moisture accumulation rate according to VDI (720 h)	-0.05 kg/m
Moisture accumulation rate defined by AGI Q112 (720 h)	0.00 kg/m ³

Note. - Nothing is stated in the ISO 12241 standard with regard to this calculation method about moisture accumulation. Results shown in TechCalc are calculated based in two different standards, VDI 2055 and AGI Q 112, with different calculation formulas and different results.

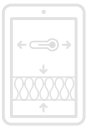

EXAMPLE 4:



A comparison between two different insulation materials (stone wool and ULTIMATE) wants to be carried out in a pipe line (Steel DN200). The insulation system has been defined as in the picture, what means a first layer of Pipe Section (100 Kg/m³ and 80 mm for stone wool and 80 Kg/m³ and 80 mm for ULTIMATE), a second layer of Wired Net Mats (80 Kg/m³ and 100 mm for stone wool and 55 Kg/m³ and 100 mm for ULTIMATE) and Aluminium cladding on top. Steel spacers will be used each 1 m and the final cladding will be stainless steel metal sheet. Inside the pipe a liquid at 280°C is running. Average climate conditions in the project area are 15°C and 3 m/s.

Steps to solve the problem:

i. Define the component inside TechCalc (see e.3.- Components – Pipes):

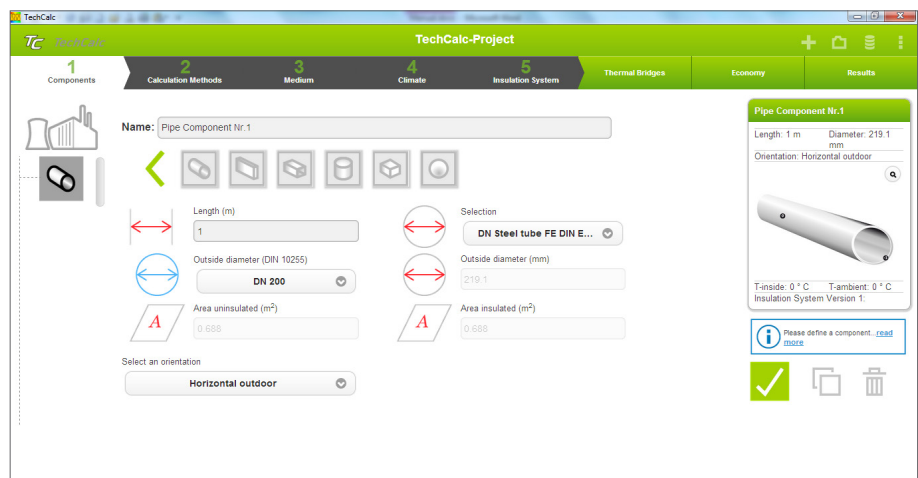

The analysis will be carried out by linear meter of pipe, so the length set inside TechCalc is 1 m in this case.



ii. Select the calculation method. In this case we need to calculate the heat loss for two different solutions, so we will choose 'Heat loss/gain and surface temperature' method (see c2.- Calculation methods)

iii. Nothing is said in the problem about the kind of media, so we will run the calculation with the pre-set value in TechCalc (Fluid) without choosing anything different from the 'Medium' database (see c3.- Medium):

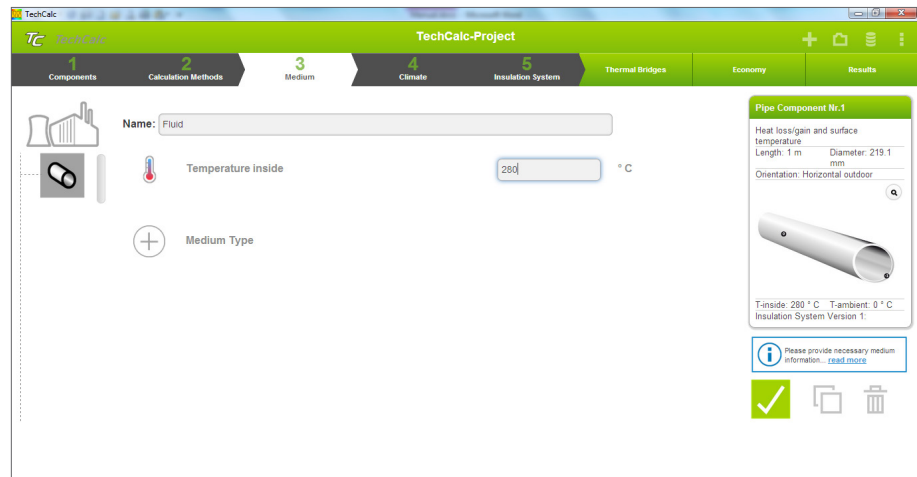

iv. Set the ambient temperature in the step 4: Climate (see c4.- Climate)

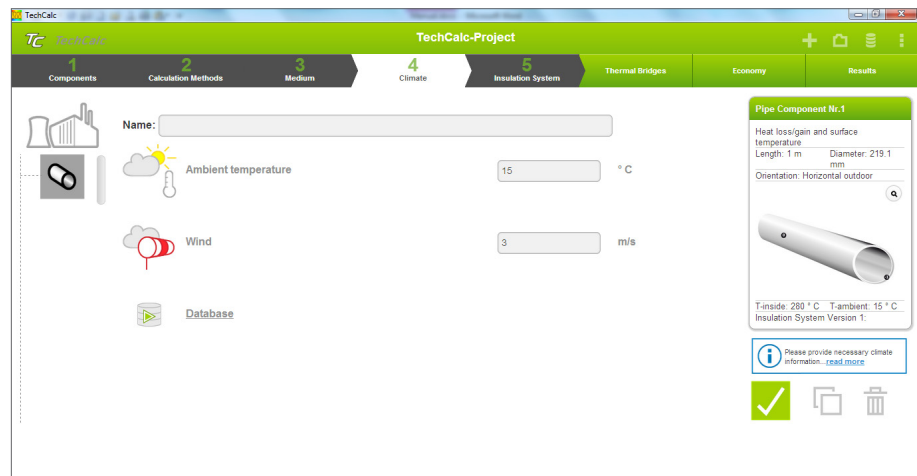

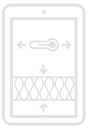

v. Define the insulation system around your duct.

a) Select the correct cladding.

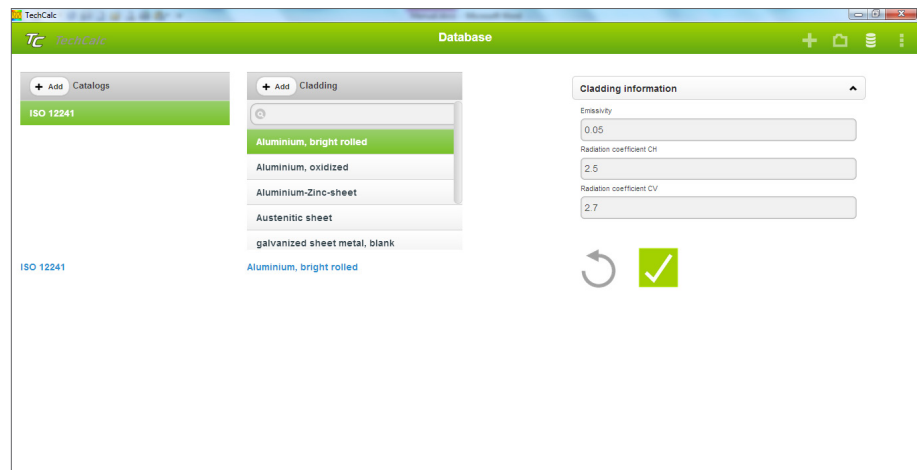

b) Select the first layer for the stone wool based system: Pipe Section 100 Kg/m³ and 80 mm.

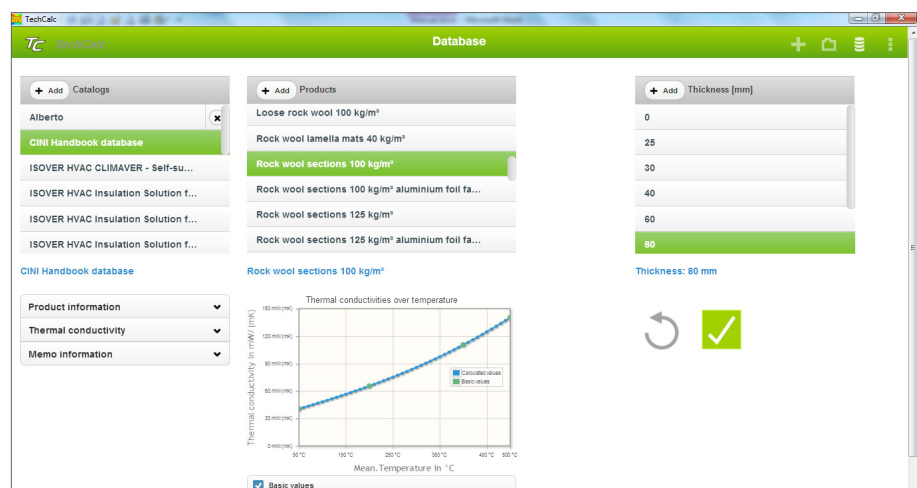

The selection has been taken from CINI database where a full mineral wool portfolio can be found.

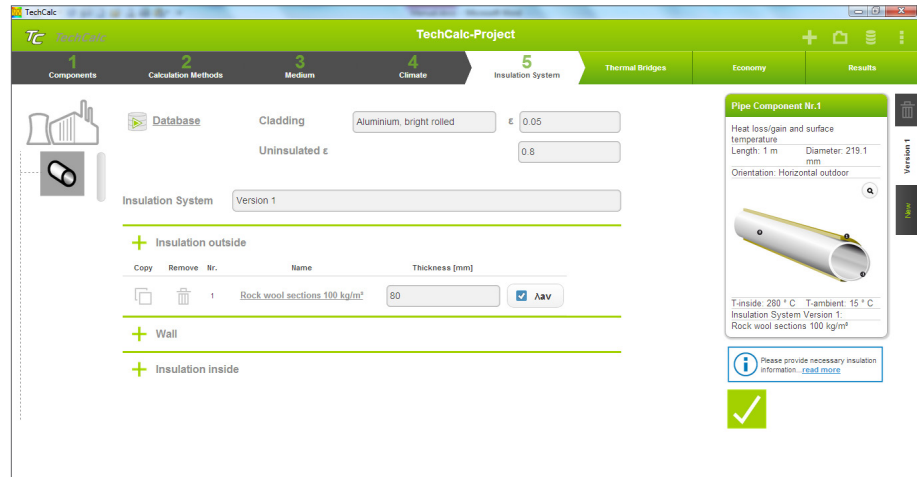

Since pipe sections declared values are based in ISO 8497, ' λ_{av} ' field must be marked. (see c.5.- Insulation System - λ_{av})

c) Select the second layer for the stone wool based system: Wired Net Mat 80 Kg/m³ and 100 mm



Since Wired Net Mats declared values are based in ISO 12667, ' λ_{av} ' field must be unmarked. (see c.5.- Insulation System - λ_{av})

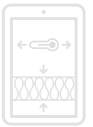

1 Components 2 Calculation Methods 3 Medium 4 Climate 5 Insulation System Thermal Bridges Economy Results

Database Cladding Aluminium, bright rolled € 0.05
Uninsulated ϵ 0.8

Insulation System Version 1

+ Insulation outside

Copy	Remove	Nr.	Name	Thickness [mm]	Aav
		1	Rock wool sections 100 kg/m ³	80	<input checked="" type="checkbox"/>
		2	Rock wool wire mesh blankets 80 kg/m ²	100	<input type="checkbox"/>

+ Wall

+ Insulation inside

Pipe Component Nr.1
Heat loss/gain and surface temperature
Length: 1 m Diameter: 219.1 mm
Orientation: Horizontal outdoor

T-inside: 280 °C T-ambient: 15 °C
Insulation System Version 1:
Rock wool wire mesh blankets 80 kg/m²
Rock wool sections 100 kg/m³

Please provide necessary insulation information. [read more](#)

✓

Home TechCalc v2.0.0.44-ib-2.0.0.9 ©2014. All rights reserved. Language: Database Language: Back

d) Create the second insulation system (see c.5.- Insulation System - Results comparison between different insulation systems)

TechCalc

TechCalc-Project

1 Components 2 Calculation Methods 3 Medium 4 Climate 5 Insulation System Thermal Bridges Economy Results

Database Cladding Aluminium, bright rolled € 0.05
Uninsulated ϵ 0.8

Insulation System Version 2

+ Insulation outside

+ Wall

+ Insulation inside

Pipe Component Nr.1
Heat loss/gain and surface temperature
Length: 1 m Diameter: 219.1 mm
Orientation: Horizontal outdoor

T-inside: 280 °C T-ambient: 15 °C
Insulation System Version 2:

Please provide necessary insulation information. [read more](#)

✓



e) Repeat steps b) and c) to create now the ULTIMATE based system

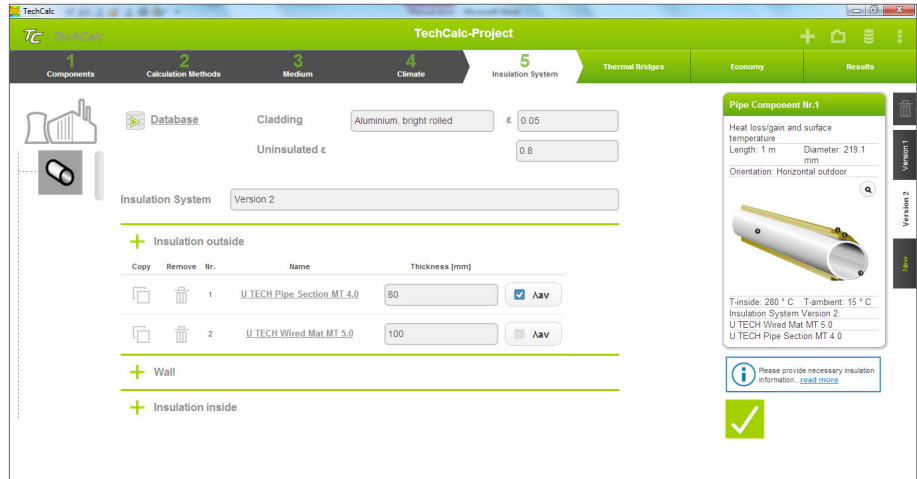

f) Define the thermal bridges (see c6.- Thermal bridges) for each system (stone wool and ULTIMATE)

Mode: Direct input Detailed

Joint-Factor

One layer Two layer Three and more layer

1.1 ⓘ

Thickness conversion factor

1

Compression conversion factor 0.98 ⓘ

Moisture conversion factor 1

Aging conversion factor 1

Convection conversion factor in the vertical insulation 1 ⓘ

Overall conversion factor (*)

1.078

Cancel OK

F factor for Stone wool-second layer

Mode: Direct input Detailed

Joint-Factor

One layer Two layer Three and more layer

1.1 ⓘ

Thickness conversion factor

1

Compression conversion factor 0.96 ⓘ

Moisture conversion factor 1

Aging conversion factor 1

Convection conversion factor in the vertical insulation 1 ⓘ

Overall conversion factor (*)

1.056

Cancel OK

F factor for ULTIMATE second layer

Given values in this example follow the recommendation stated in ISO 23993.

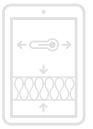

$\Delta\lambda$ is the same for both systems:

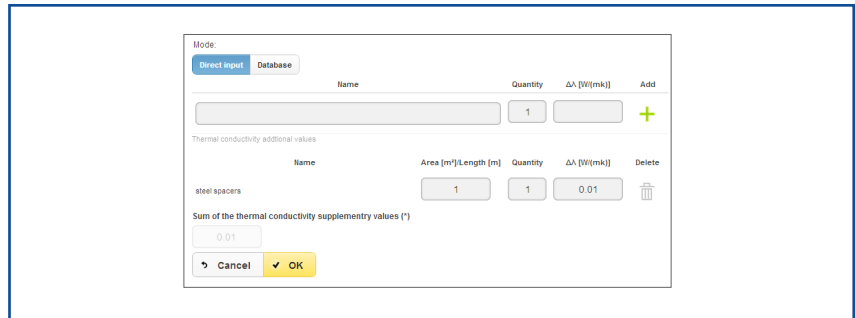
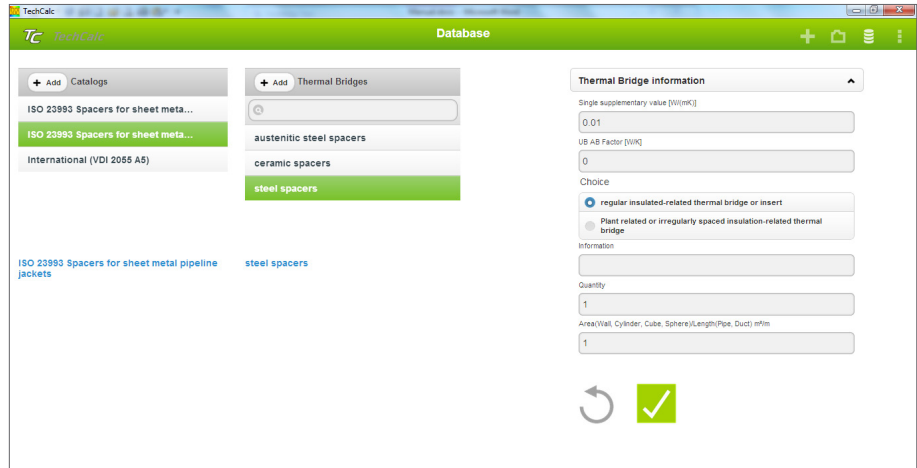

The final result for stone wool system is:

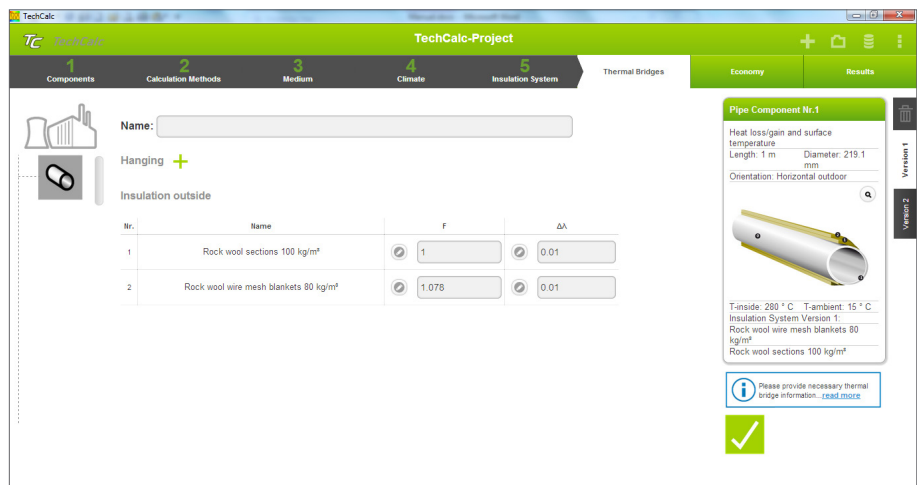



And final result for ULTIMATE system is:

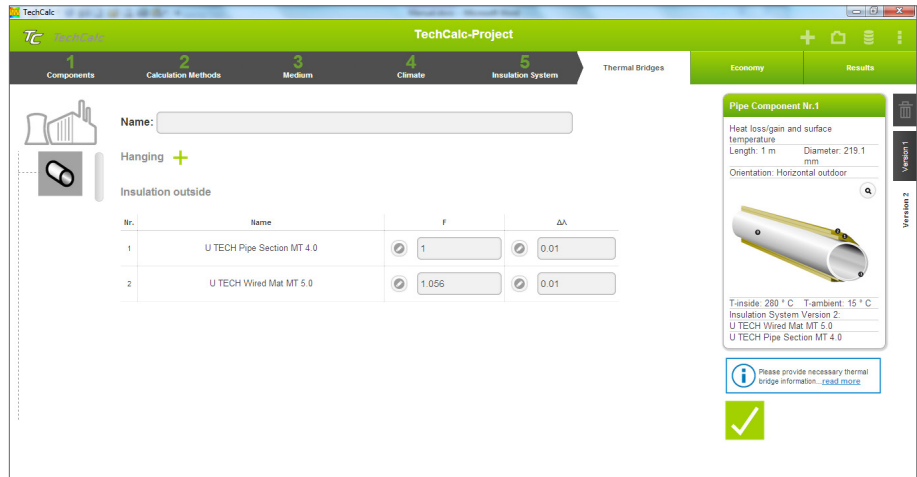

vi. Check the final results to give an answer to the problem: compare both insulation systems in terms of heat loss:

Summary of results			
	Version 1 (Thermal Bridge)	Version 2 (Thermal Bridge)	Saving
Heatloss	116.29 W/m	108.53 W/m	7.76 W/m
Heatloss (Area insulated)	63.93 W/m ²	59.67 W/m ²	4.27 W/m ²
Total heatloss	116.29 W	108.53 W	7.76 W
T-surface	17.50 °C	17.34 °C	

Pipe Component Nr.1

Heatloss: 108.53 W/m
 T-inside: 280.00 °C
 T[-1]: 280.00 °C
 T[0]: 280.00 °C
 T[1]: 155.88 °C
 T[2]: 17.34 °C
 T-surface: 17.34 °C
 T-ambient: 15.00 °C

STONE WOOL

Length: 1.00 m
 Diameter: 219.10 mm
 Orientation: Horizontal outdoor
 Cladding: Aluminium, bright rolled, c.0.05
 Insulation outside:
 1. U TECH Pipe Section MT 4.0: 80 mm
 2. U TECH Wired Mat MT 5.0: 100 mm

Pipe Component Nr.1

Heatloss: 116.29 W/m
 T-inside: 280.00 °C
 T[-1]: 280.00 °C
 T[0]: 280.00 °C
 T[1]: 149.54 °C
 T[2]: 17.50 °C
 T-surface: 17.50 °C
 T-ambient: 15.00 °C

ULTIMATE

Length: 1.00 m
 Diameter: 219.10 mm
 Orientation: Horizontal outdoor
 Cladding: Aluminium, bright rolled, c.0.05
 Insulation outside:
 1. Rock wool sections 100 kg/m³: 80 mm
 2. Rock wool wire mesh blankets 80 kg/m³: 100 mm

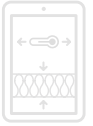

EXAMPLE 5:

Based in the previous example (4) calculate the payback time for the best performing solution knowing that the total installed cost for the stone wool based system is 143,5 €/lm and for the ULTIMATE based system is 160 €/lm. Compare also the CO2 emissions savings between the two solutions knowing that the energy source is gas (0,04 €/kWh) and the total amount of working hours per year is 7.500 h.

Previous considerations:

Given total installed costs (installation plus material) are only for a demonstration purpose, so they don't necessary need to be adjusted to the reality.

Steps to solve the problem:

- i. Define the component inside TechCalc. Repeat example 4
- ii. Select the calculation method. In this case we need to calculate the payback time and CO2 emissions for two different solutions, so we will choose 'Operational cost' method (see c2.- Calculation methods)
- iii. For 'Medium' definition, do the same than in example 4 but adding the 'Operational hours'

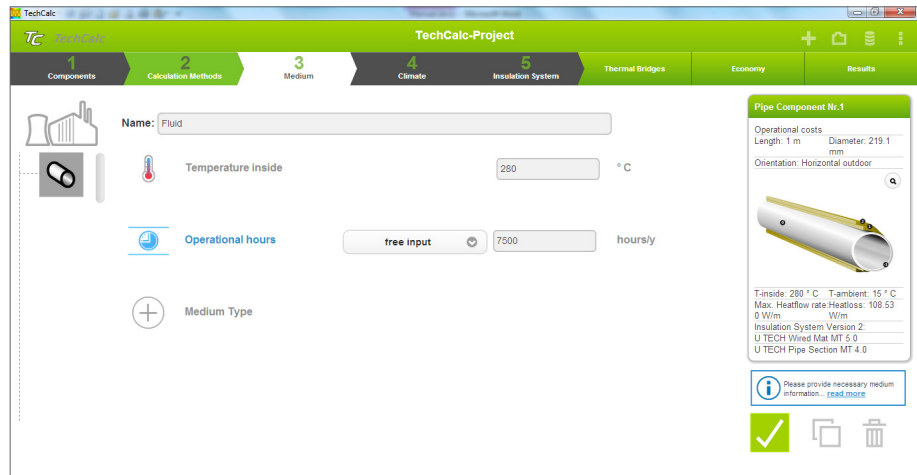

- iv. For 'Climate' definition repeat the same than in example 4 but adding the 'Energy Source CO2 emissions', in this case gas:





v. For the 'Insulation System' definition repeat steps done in example 4 but adding the 'Total costs' for both solutions:

Copy	Remove	Nr.	Name	Thickness [mm]	Aav
<input type="checkbox"/>	<input type="checkbox"/>	1	Rock wool sections 100 kg/m ³	80	<input checked="" type="checkbox"/>
<input type="checkbox"/>	<input type="checkbox"/>	2	Rock wool wire mesh blankets 80 kg/m ³	100	<input type="checkbox"/>

Total costs: 143.5 EUR

Copy	Remove	Nr.	Name	Thickness [mm]	Aav
<input type="checkbox"/>	<input type="checkbox"/>	1	U.TECH.Pipe.Section.MT.4.0	80	<input checked="" type="checkbox"/>
<input type="checkbox"/>	<input type="checkbox"/>	2	U.TECH.Wired.Mat.MT.5.0	100	<input type="checkbox"/>

Total costs: 160 EUR

vi. Define 'Thermal Bridges' as in example 4

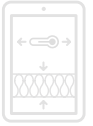

vii. Fill in the values for 'Economy' (See c2.- Calculation methods - Operational cost)

viii. Check the final results to give an answer to the problem: compare both insulation systems in terms of economy and CO₂ emissions:

Summary of results			
	Version 1 (Thermal Bridge)	Version 2 (Thermal Bridge)	Saving
Heatloss	116.29 W/m	108.53 W/m	7.76 W/m
Heatloss (Area insulated)	63.93 W/m ²	59.67 W/m ²	4.27 W/m ²
Total heatloss	116.29 W	108.53 W	7.76 W
T-surface	17.50 °C	17.34 °C	
Energy Consumption (7500 h/a)	872.17 kWh/a	813.98 kWh/a	58.19 kWh/a
Operational costs (0.04 EUR/kWh)	34.89 EUR/a	32.56 EUR/a	2.33 EUR/a
Insulation costs	143.50 EUR	160.00 EUR	-16.50 EUR
Payback time			7.0890 a
CO ₂ emission (0.250 kg/kWh)	320.52 kg/a	299.14 kg/a	21.38 kg/a

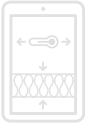

G. DISCLAIMER

Calculation results are based exclusively on entered values and boundary conditions. These calculations are only an estimation of the actual temperatures and heat losses because it is impossible to accurately define real life conditions such as radiation received, wind speed, relative humidity, etc.

TC[®] TechCalc

Thermal Calculation Software for Technical Insulation 2.0



Saint-Gobain ISOVER

Les Miroirs
18 avenue d'Alsace
92096 PARIS

LA DEFENSE - Cedex France
www.isover-technical-insulation.com

The information given in this brochure is based on our current knowledge and experience. If any information is incorrect this is not deliberate or grossly negligent. This document is not continually updated and we cannot be held responsible for any unintentional errors. For the most up-to-date information, please visit our website: www.isover-technical-insulation.com